

Λ
95/1

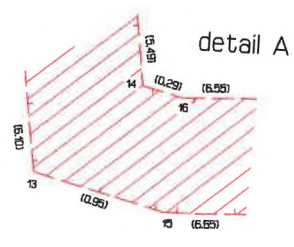

Seznam souřadnic (S-JTSK)

Číslo bodu	Souřadnice pro zápis do KN	Kód kv.
	Y X	
51-228	887561.93 1062327.64	8
51-719	887213.96 1063219.47	8
51-816	887166.93 1063299.69	8
1	887969.80 1062456.63	3
2	887968.26 1062462.02	3
3	887969.06 1062462.12	3
9	887966.97 1062476.88	3
10	887966.17 1062476.78	3
11	887966.39 1062481.18	8
12	887965.58 1062481.14	8
13	887965.57 1062487.22	3
14	887964.85 1062486.58	3
15	887964.65 1062467.45	3
16	887964.57 1062486.65	3
17	887968.01 1062467.14	3
18	887958.03 1062486.34	3
19	887945.57 1062486.80	3
20	887945.61 1062486.00	3
21	887933.68 1062486.23	3
22	887933.72 1062485.43	3
23	887922.96 1062485.64	3
24	887923.00 1062484.84	3
25	887918.39 1062485.33	3
26	887918.43 1062484.53	3
27	887908.38 1062485.04	3
28	887908.40 1062484.24	3
29	887898.23 1062484.77	3
30	887898.27 1062483.97	3

Seznam souřadnic (S-JTSK)

Číslo bodu	Souřadnice pro zápis do KN	Kód kv.
	Y X	
31	887891.55 1062484.28	3
32	887891.61 1062483.48	3
33	887879.31 1062483.19	3
34	887879.37 1062482.39	3
35	887872.02 1062482.57	3
36	887872.12 1062481.77	3
37	887859.17 1062480.39	3
38	887859.33 1062479.61	3
39	887854.35 1062479.19	3
40	887854.55 1062478.41	3
41	887844.13 1062476.70	3
42	887844.33 1062475.92	3
43	887830.82 1062473.40	3
44	887831.02 1062472.62	3
45	887819.90 1062470.51	3
46	887820.10 1062469.73	3
47	887803.41 1062465.97	3
48	887803.63 1062465.19	3
49	887783.57 1062460.35	3
50	887783.79 1062459.59	3
51	887767.04 1062455.67	3
52	887767.30 1062454.91	3
53	887763.25 1062454.16	3
54	887763.47 1062453.38	3
55	887760.99 1062453.77	3
56	887761.19 1062452.99	3
57	887753.34 1062451.21	3
58	887753.62 1062450.45	3
59	887744.17 1062447.64	3

99/2

197/2

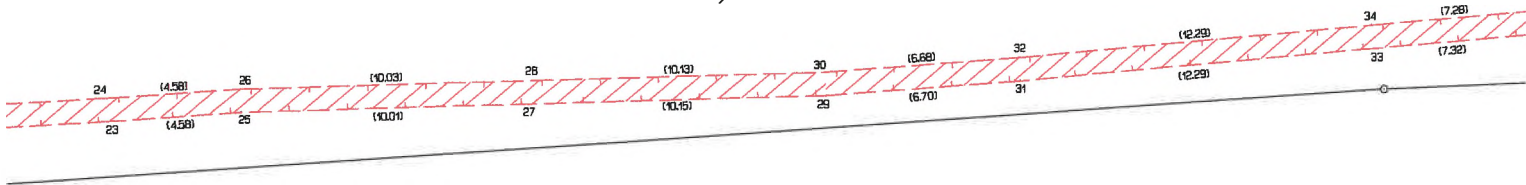

95/1

Seznam souřadnic (S-JTSK)
Číslo bodu Souřadnice pro zápis do KN

	Y	X	Kód kv.
60	887744.49	1062446.90	3
61	887734.97	1062443.30	3
62	887735.31	1062442.58	3
63	887719.39	1062435.91	3
64	887719.75	1062435.19	3
65	887703.53	1062427.53	3
66	887703.91	1062426.63	3
67	887689.73	1062419.93	3
68	887690.13	1062419.23	3
69	887677.28	1062412.76	3
70	887677.68	1062412.06	3
71	887660.23	1062402.68	3
72	887660.65	1062402.00	3
73	887651.97	1062397.42	3
74	887652.41	1062396.76	3
75	887642.00	1062390.58	3
76	887642.46	1062389.92	3
77	887628.27	1062380.92	3
78	887628.73	1062380.28	3
79	887614.72	1062370.99	3
80	887615.22	1062370.35	3
81	887607.44	1062364.98	3
82	887607.92	1062364.34	3
83	887604.71	1062363.03	3
84	887605.19	1062362.39	3
85	887597.51	1062357.47	3
86	887598.01	1062356.85	3
87	887590.82	1062351.93	3
88	887591.34	1062351.31	3
89	887579.61	1062342.21	3
90	887580.13	1062341.61	3
91	887572.08	1062335.62	3
92	887572.60	1062335.00	3
93	887569.72	1062333.70	3
94	887570.22	1062333.08	3

Seznam souřadnic (S-JTSK)
Číslo bodu Souřadnice pro zápis do KN

	Y	X	Kód kv.
95	887567.24	1062331.70	3
96	887567.72	1062331.06	3
97	887562.85	1062328.46	8
98	887563.68	1062328.07	3
99	887562.01	1062326.96	3
100	887556.19	1062325.48	3
101	887561.47	1062327.61	8
102	887556.45	1062324.72	3
103	887553.50	1062324.66	3
104	887553.68	1062323.88	3
105	887550.07	1062324.12	3
106	887550.11	1062323.32	3
107	887542.39	1062324.39	3
108	887542.99	1062323.59	3
109	887537.93	1062324.23	3
110	887537.95	1062323.43	3
111	887531.48	1062324.14	3
112	887531.46	1062323.34	3
113	887527.41	1062324.34	3
114	887527.37	1062323.54	3
115	887518.75	1062324.84	8
116	887519.67	1062323.98	3
117	887510.78	1062323.54	3
118	887510.00	1062323.56	3

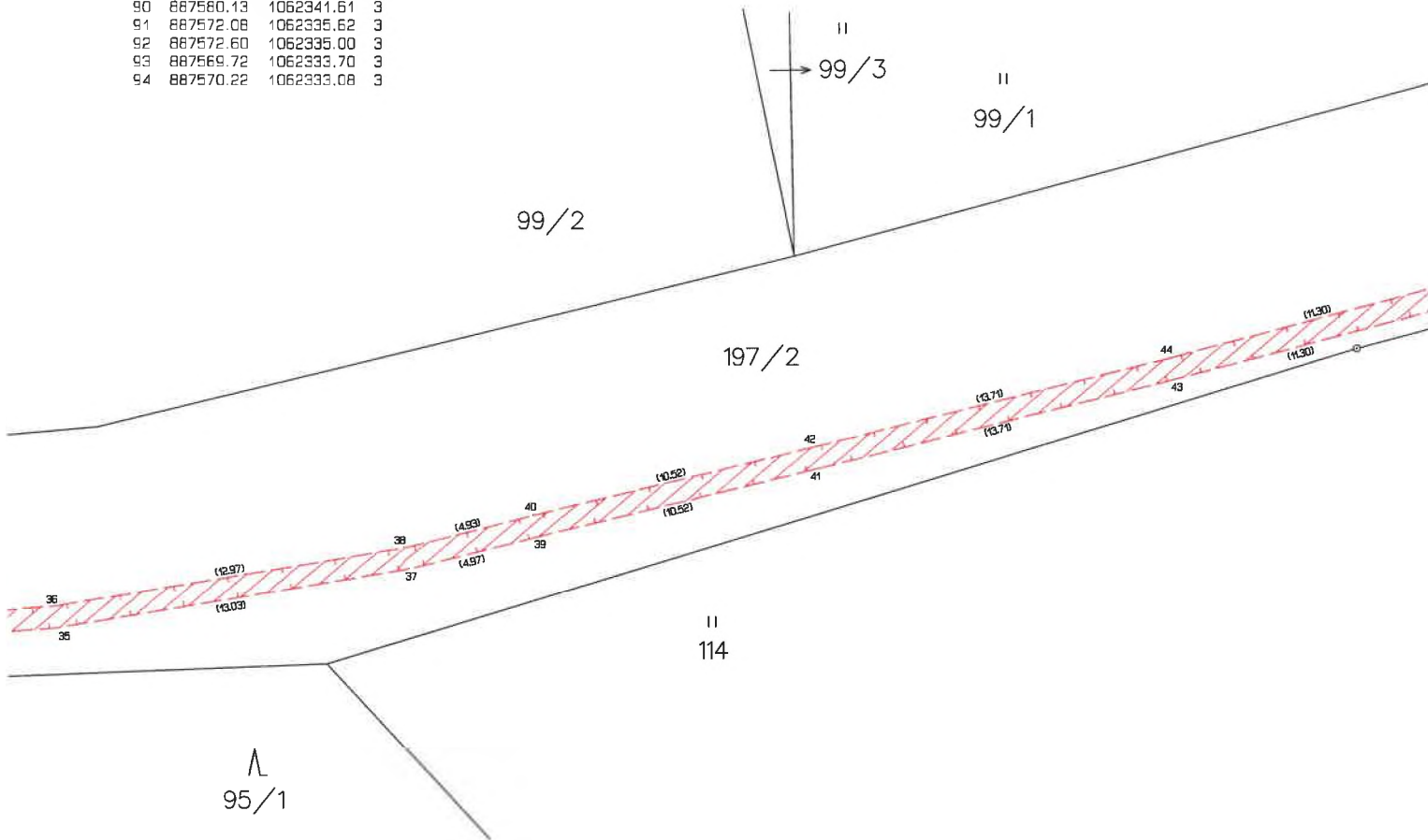

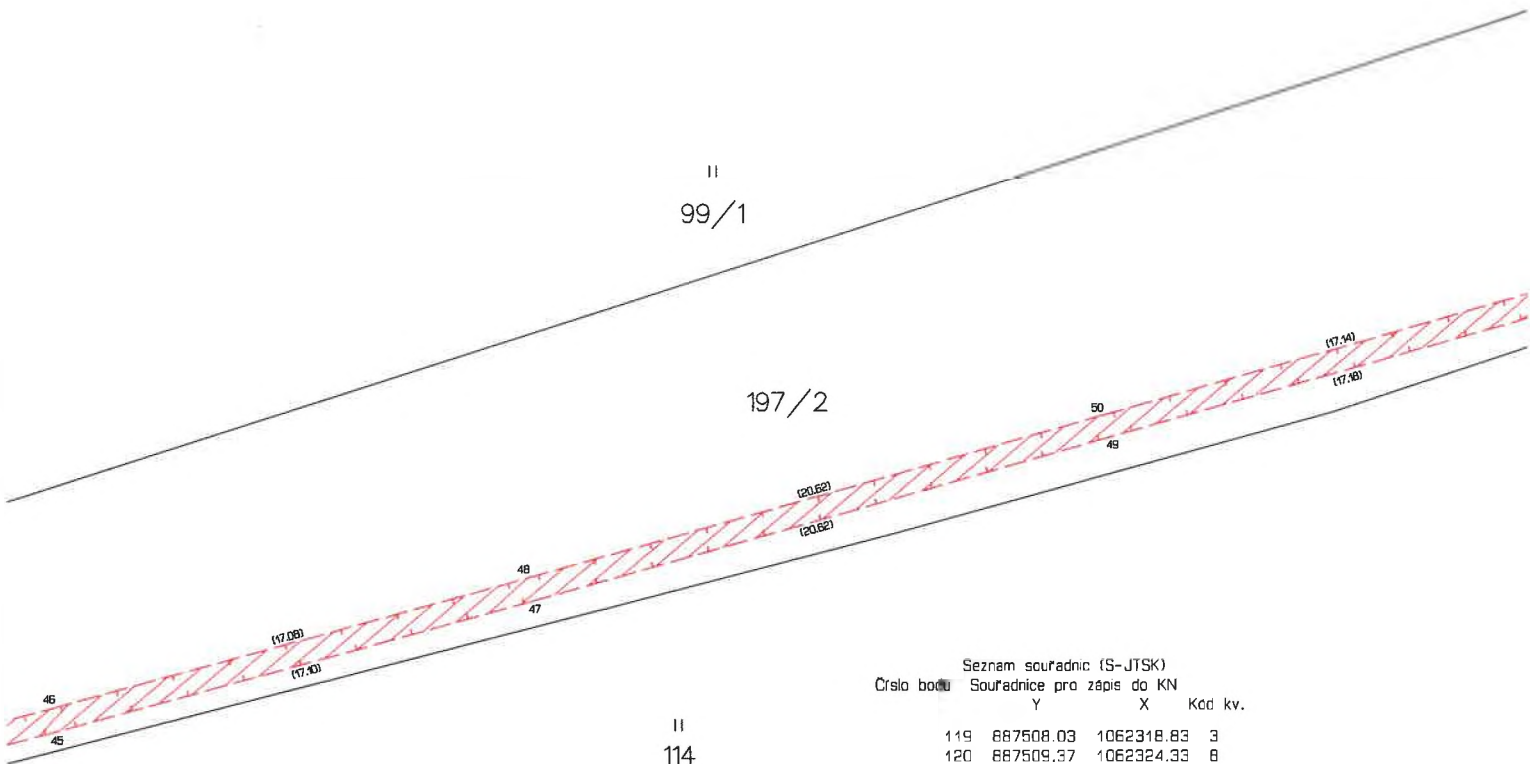

II
114

Seznam souřadnic (S-JTSK)

Číslo bodu	Souřadnice pro zápis do KN	Y	X	Kód kv.
119	887508.03	1062318.83	3	
120	887509.37	1062324.33	8	
121	887508.75	1062318.41	3	
122	887507.73	1062318.53	3	
123	887508.07	1062317.75	3	
124	887504.06	1062318.30	3	
125	887504.12	1062317.50	3	
126	887497.39	1062317.57	3	
127	887497.47	1062316.77	3	
128	887464.46	1062316.46	3	
129	887464.54	1062315.66	3	
130	887471.64	1062315.16	3	
131	887471.72	1062314.36	3	
132	887459.79	1062314.18	3	
133	887459.85	1062313.38	3	
134	887447.48	1062313.07	3	
135	887447.56	1062312.27	3	
136	887439.10	1062312.08	3	
137	887439.10	1062311.28	3	
138	887438.57	1062312.14	3	
139	887438.01	1062311.40	3	
140	887437.77	1062312.00	3	
141	887437.97	1062320.43	3	
142	887437.19	1062320.05	3	
143	887437.26	1062321.04	3	
144	887436.88	1062320.32	3	
145	887436.05	1062321.37	3	
146	887435.81	1062320.61	3	
147	887434.96	1062321.77	3	
148	887434.60	1062321.05	3	
149	887432.80	1062323.15	3	
150	887432.28	1062322.53	3	
151	887430.57	1062325.51	3	
152	887429.95	1062325.01	3	
153	887428.07	1062329.26	3	

Seznam souřadnic (S-JTSK)
Číslo bodu Souřadnice pro zápis do KN
Y X Kód kv.

Číslo bodu	Y	X	Kód kv.
154	887427.39	1062328.84	3
155	887424.52	1062335.46	3
156	887423.82	1062335.08	3
157	887422.07	1062340.62	3
158	887421.33	1062340.30	3
159	887418.04	1062350.93	3
160	887417.28	1062350.67	3
161	887415.07	1062360.48	3
162	887414.29	1062360.26	3
163	887412.29	1062371.55	3
164	887411.51	1062371.37	3
165	887410.37	1062381.11	3
166	887409.59	1062380.97	3
167	887409.13	1062389.96	3
168	887408.33	1062389.84	3
169	887407.49	1062399.84	3
170	887406.69	1062399.72	3
171	887405.20	1062416.60	3
172	887404.40	1062416.48	3
173	887404.71	1062419.70	3
174	887403.91	1062419.58	3
175	887403.78	1062426.44	3
176	887402.98	1062426.32	3
177	887402.24	1062436.93	3
178	887401.44	1062436.81	3
179	887399.54	1062453.18	3
180	887398.76	1062453.04	3
181	887396.82	1062468.91	3
182	887396.02	1062468.79	3
183	887395.61	1062477.93	3
184	887394.81	1062477.81	3
185	887393.08	1062492.64	3

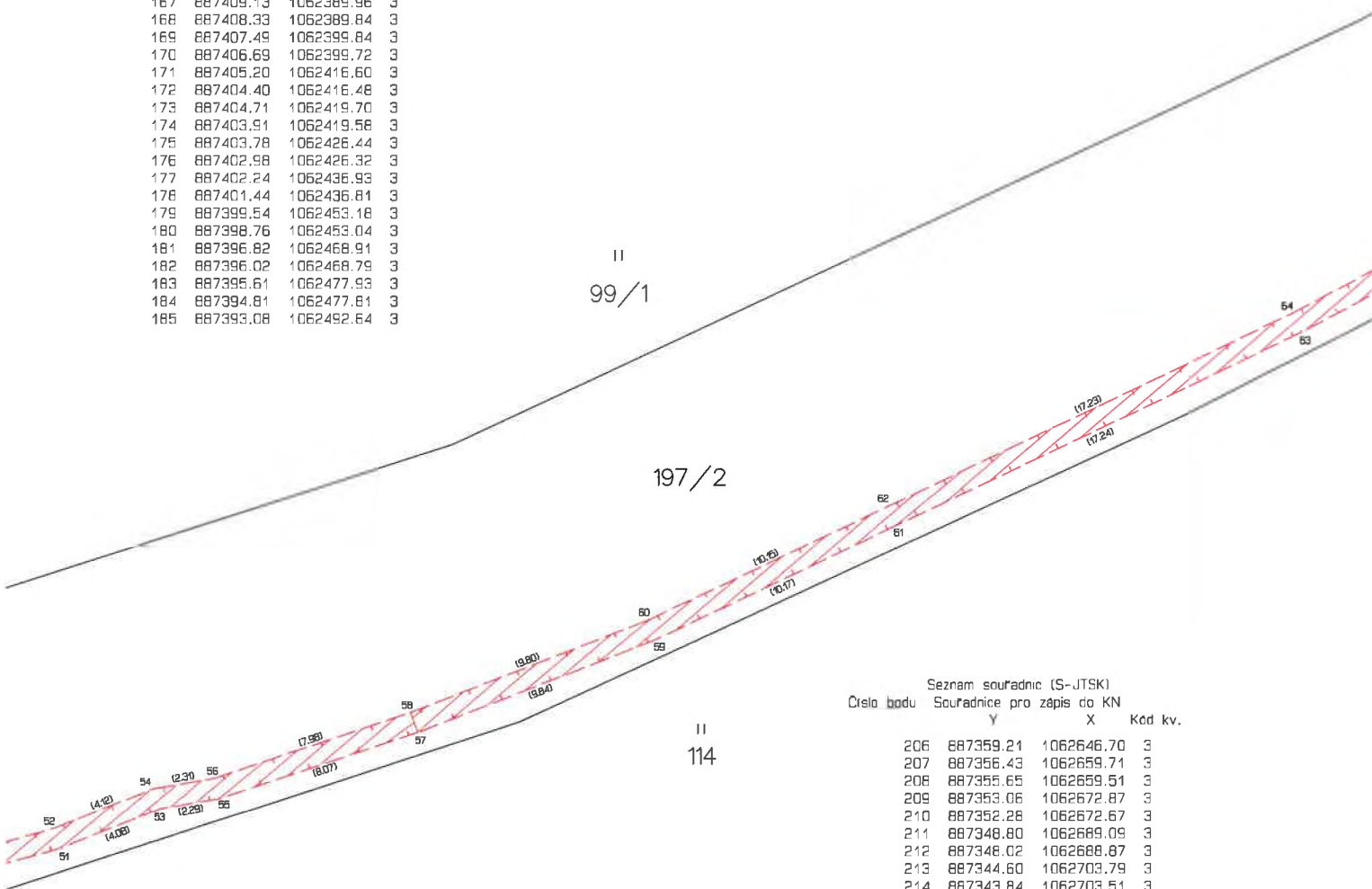

Seznam souřadnic (S-JTSK)
Číslo bodu Souřadnice pro zápis do KN
Y X Kód kv.

Číslo bodu	Y	X	Kód kv.
206	887359.21	1062646.70	3
207	887356.43	1062659.71	3
208	887355.65	1062659.51	3
209	887353.06	1062672.87	3
210	887352.28	1062672.67	3
211	887348.80	1062689.09	3
212	887348.02	1062688.87	3
213	887344.60	1062703.79	3
214	887343.84	1062703.51	3
215	887343.55	1062706.19	3
216	887342.79	1062705.95	3
217	887343.10	1062708.48	3
218	887342.32	1062708.28	3
219	887340.60	1062716.82	3
220	887339.84	1062716.58	3
221	887334.14	1062738.05	3
222	887333.36	1062737.81	3
223	887332.88	1062741.67	3
224	887332.12	1062741.45	3
225	887331.83	1062745.99	3
226	887331.05	1062745.79	3
227	887327.52	1062761.16	3
228	887326.76	1062760.94	3
229	887323.09	1062775.49	3
230	887322.33	1062775.25	3
231	887322.10	1062778.58	3
232	887321.34	1062778.36	3
233	887320.82	1062783.65	3
234	887320.04	1062783.43	3
235	887316.21	1062799.07	3
236	887315.45	1062798.85	3
237	887311.51	1062815.05	3
238	887310.75	1062814.83	3
239	887307.02	1062831.40	3

Seznam souřadnic (S-JTSK)
Číslo bodu Souřadnice pro zápis do KN
Y X Kód kv.

Číslo bodu	Y	X	Kód kv.
186	887392.30	1062492.50	3
187	887390.67	1062504.26	3
188	887389.89	1062504.12	3
189	887388.18	1062519.98	3
190	887387.40	1062519.84	3
191	887385.70	1062533.57	3
192	887384.92	1062533.43	3
193	887382.55	1062549.89	3
194	887381.77	1062549.73	3
195	887379.07	1062567.50	3
196	887378.29	1062567.34	3
197	887376.17	1062582.86	3
198	887375.99	1062582.70	3
199	887371.94	1062601.47	3
200	887371.16	1062601.29	3
201	887367.87	1062616.57	3
202	887367.09	1062616.17	3
203	887362.85	1062636.82	3
204	887362.07	1062636.60	3
205	887359.99	1062646.92	3

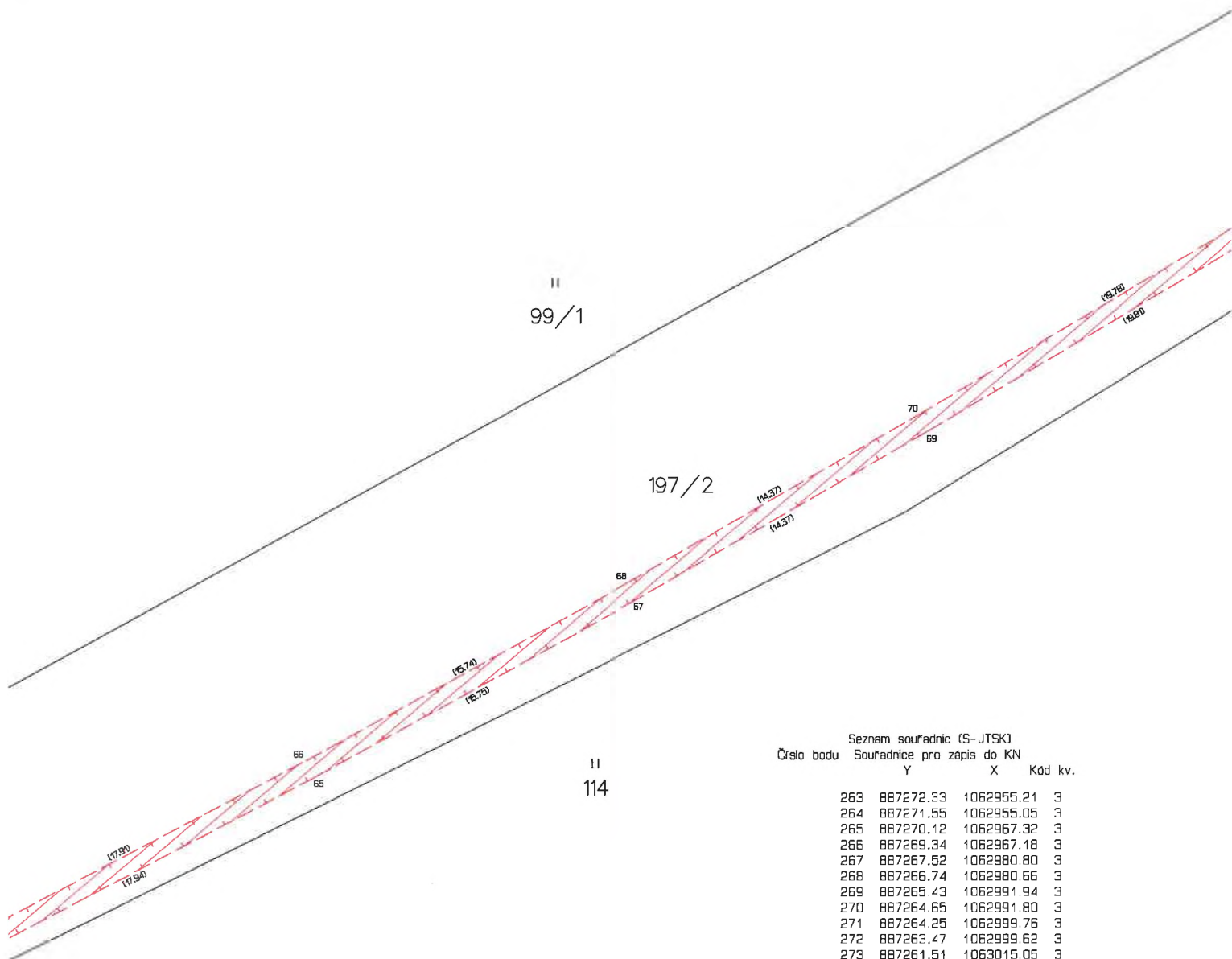

Seznam souřadnic (S-JTSK)

Číslo bodu	Souřadnice pro zápis do KN		Kód kv.
	Y	X	
240	887306.24	1062831.18	3
241	887302.12	1062848.76	3
242	887301.36	1062848.54	3
243	887297.78	1062863.89	3
244	887297.00	1062863.67	3
245	887296.09	1062870.11	3
246	887295.31	1062869.91	3
247	887295.40	1062873.20	3
248	887294.64	1062872.94	3
249	887294.72	1062874.72	3
250	887293.96	1062874.44	3
251	887290.37	1062888.89	3
252	887289.61	1062888.67	3
253	887287.25	1062899.89	3
254	887286.49	1062899.67	3
255	887284.54	1062909.14	3
256	887283.78	1062908.92	3
257	887281.93	1062918.11	3
258	887281.17	1062917.89	3
259	887277.99	1062931.76	3
260	887277.21	1062931.56	3
261	887275.04	1062943.54	3
262	887274.26	1062943.36	3

Seznam souřadnic (S-JTSK)

Číslo bodu	Souřadnice pro zápis do KN		Kód kv.
	Y	X	
263	887272.33	1062955.21	3
264	887271.55	1062955.05	3
265	887270.12	1062967.32	3
266	887269.34	1062967.18	3
267	887267.52	1062980.80	3
268	887266.74	1062980.66	3
269	887265.43	1062991.94	3
270	887264.65	1062991.80	3
271	887264.25	1062999.76	3
272	887263.47	1062999.62	3
273	887261.51	1063015.05	3
274	887260.73	1063014.89	3
275	887259.69	1063023.99	3
276	887258.91	1063023.83	3
277	887256.81	1063038.85	3
278	887256.03	1063038.69	3
279	887253.83	1063053.51	3
280	887253.05	1063053.37	3
281	887252.01	1063064.40	3
282	887251.23	1063064.26	3
283	887251.51	1063066.81	3
284	887250.67	1063066.98	3
285	887254.24	1063068.63	3
286	887248.82	1063069.47	3
287	887250.85	1063072.30	3
288	887250.10	1063071.96	3
289	887249.92	1063076.37	3
290	887249.14	1063076.21	3
291	887248.68	1063083.46	3
292	887247.90	1063083.34	3
293	887247.50	1063091.32	3
294	887246.70	1063091.22	3
295	887246.49	1063099.94	3
296	887245.69	1063099.86	3
297	887245.69	1063108.06	3
298	887244.89	1063107.98	3
299	887244.98	1063115.56	3
300	887244.18	1063115.48	3

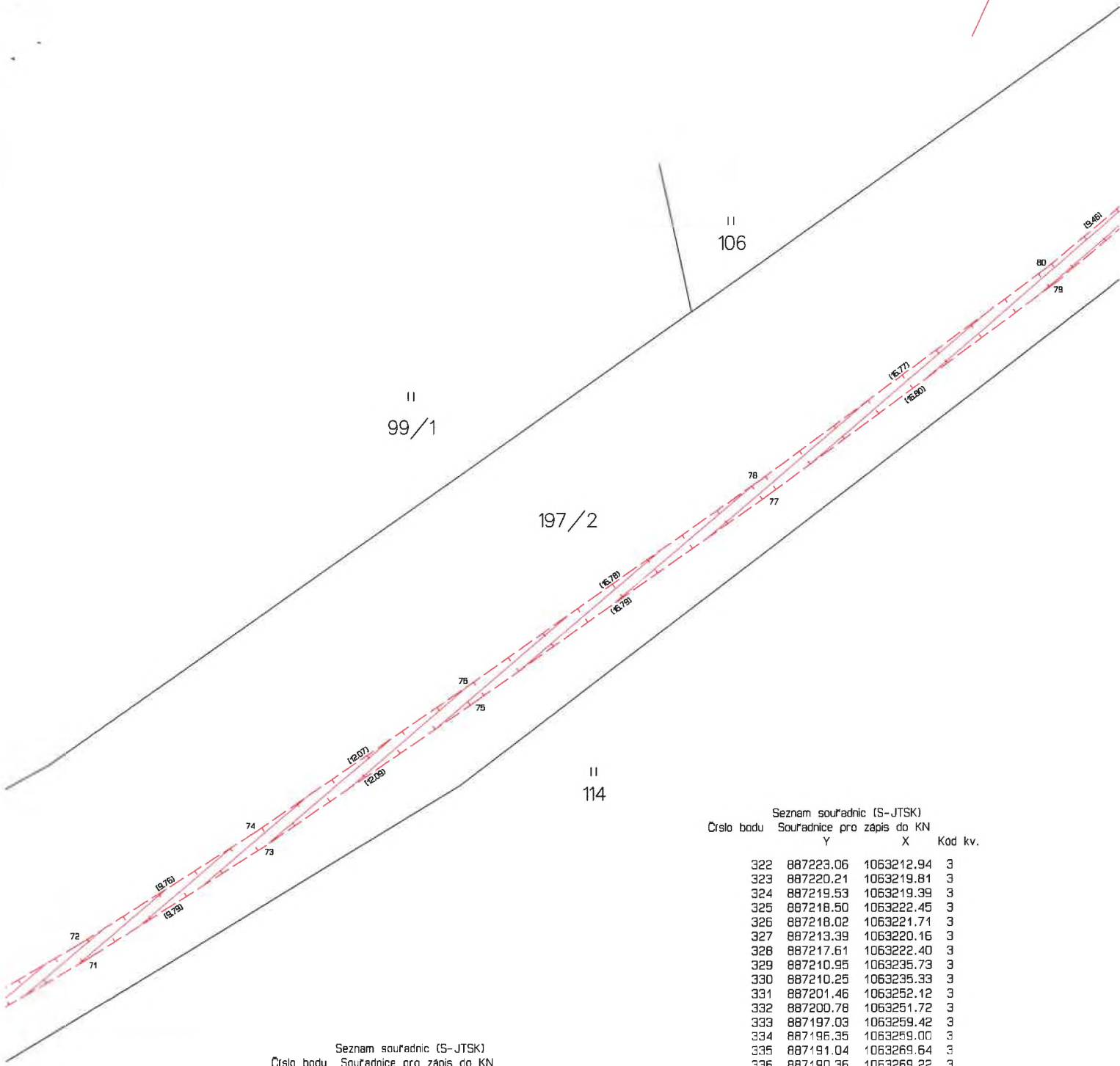

Seznam souřadnic (S-JTSK)
Číslo bodu Souřadnice pro zápis do KN

Číslo bodu	Y	X	Kód kv.
301	887243.27	1063133.03	3
302	887242.47	1063132.95	3
303	887242.63	1063139.08	3
304	887241.83	1063139.00	3
305	887241.51	1063150.69	3
306	887240.71	1063150.59	3
307	887239.60	1063164.68	3
308	887238.82	1063164.54	3
309	887238.44	1063170.64	3
310	887237.66	1063170.48	3
311	887237.23	1063175.75	3
312	887236.45	1063175.55	3
313	887234.98	1063184.08	3
314	887234.20	1063183.66	3
315	887232.95	1063191.31	3
316	887232.19	1063191.07	3
317	887231.22	1063196.28	3
318	887230.46	1063196.00	3
319	887228.86	1063202.55	3
320	887228.12	1063202.23	3
321	887223.78	1063213.30	3

Seznam souřadnic (S-JTSK)
Číslo bodu Souřadnice pro zápis do KN

Číslo bodu	Y	X	Kód kv.
322	887223.06	1063212.94	3
323	887220.21	1063219.81	3
324	887219.53	1063219.39	3
325	887218.50	1063222.45	3
326	887218.02	1063221.71	3
327	887213.39	1063220.16	3
328	887217.61	1063222.40	3
329	887210.95	1063235.73	3
330	887210.25	1063235.33	3
331	887201.46	1063252.12	3
332	887200.78	1063251.72	3
333	887197.03	1063259.42	3
334	887196.35	1063259.00	3
335	887191.04	1063269.64	3
336	887190.36	1063269.22	3
337	887183.28	1063282.38	3
338	887182.60	1063281.96	3
339	887176.61	1063293.77	3
340	887175.91	1063293.37	3
341	887171.95	1063302.24	3
342	887171.29	1063301.78	3
343	887171.18	1063303.17	3
344	887171.00	1063302.13	3
345	887166.34	1063300.24	3
346	887166.74	1063299.58	8
347	887213.75	1063219.37	8
348	887166.52	1063300.35	8
349	887213.61	1063220.28	8
350	887437.26	1062319.08	8
351	887438.06	1062319.23	8
352	887449.95	1062312.49	8
353	887449.61	1062313.26	8

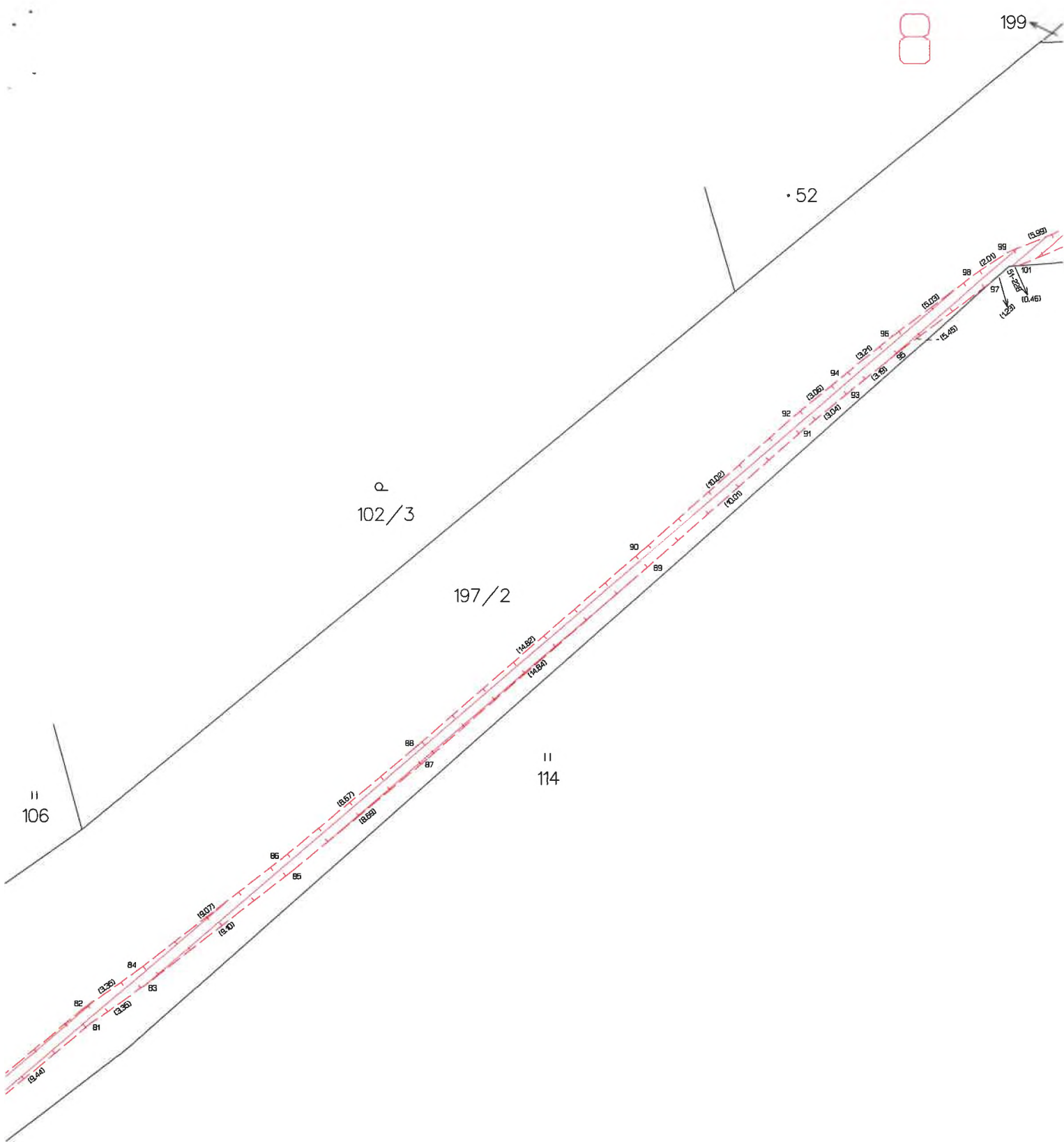

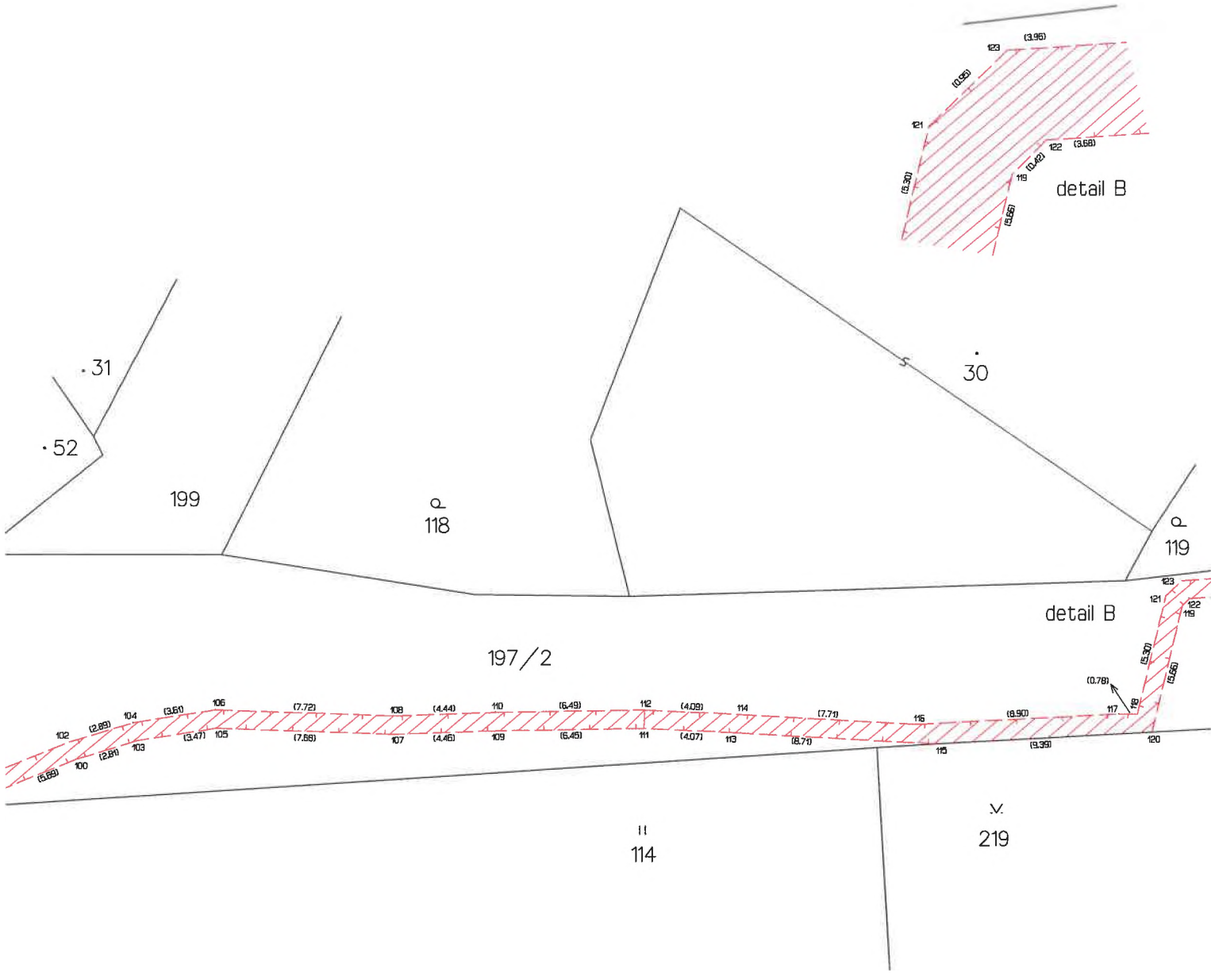

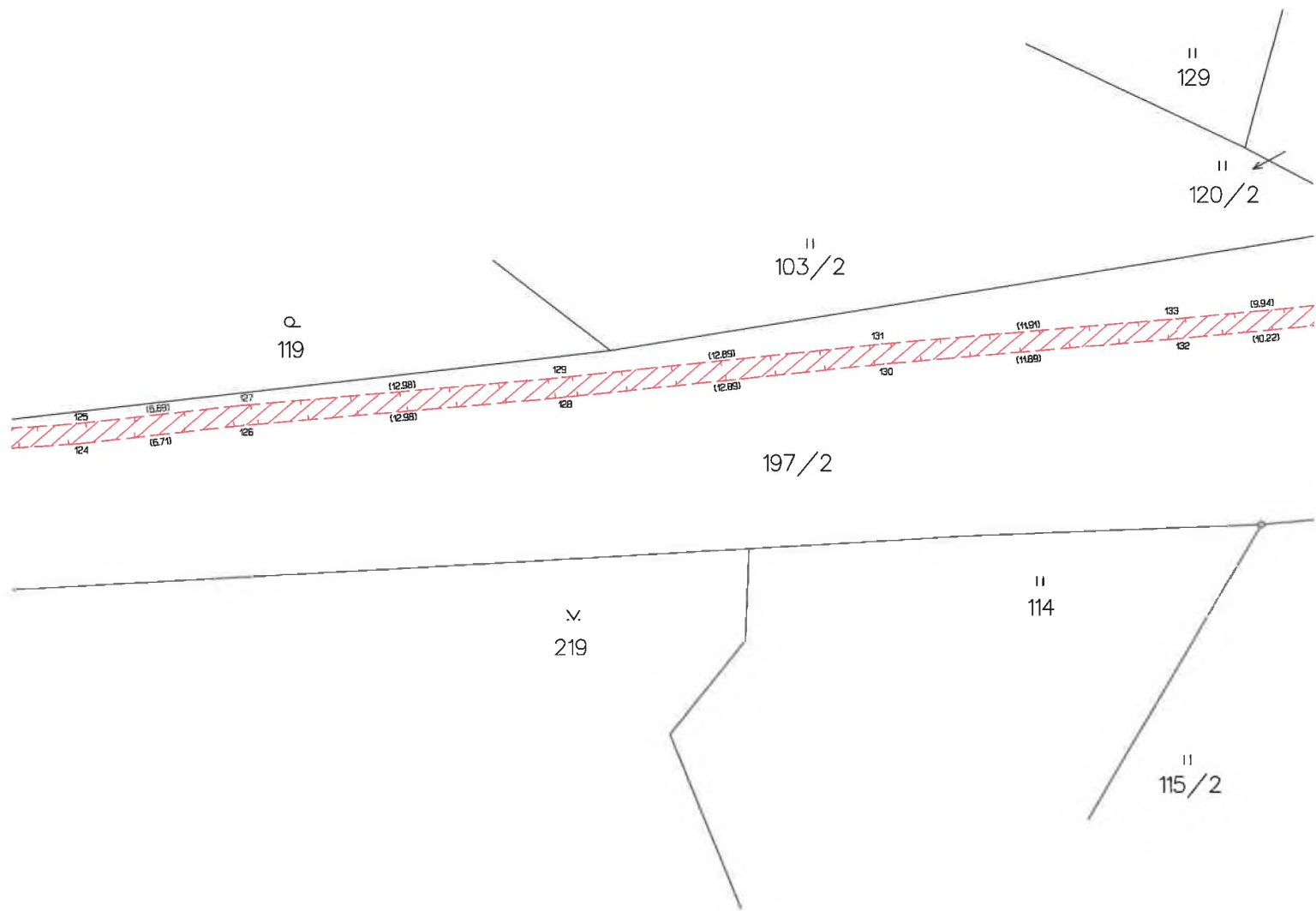

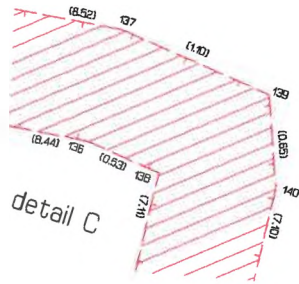

detail C

" 120/2

" 121

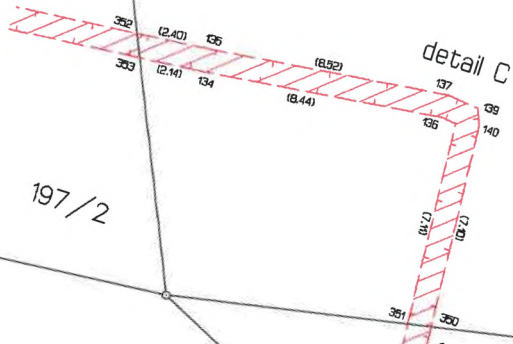

detail C

197/2

197/1



detail D

" 115/2

213/1

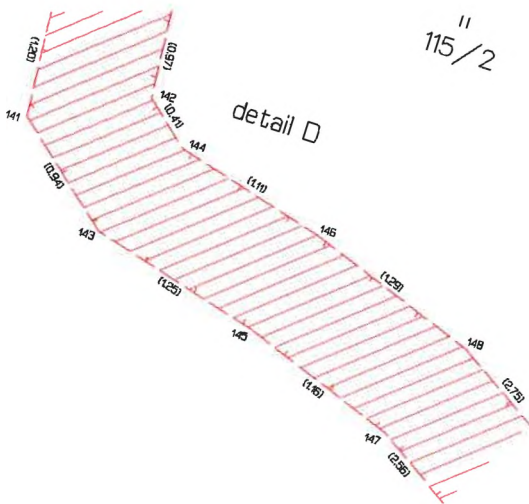

detail D

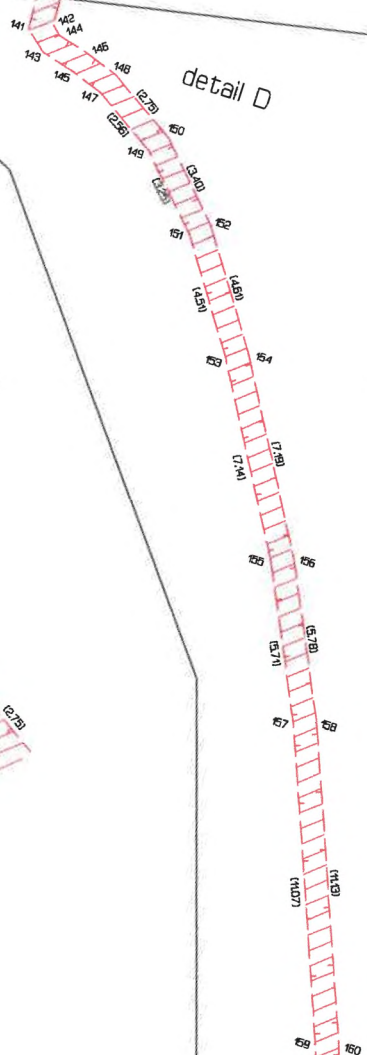

detail D

162

(1445)
(1440)

163

(1473)
(1475)

164

(1490)
(1494)

165

(1502)
(1507)

169

(1592)
(1597)

171

(1344)
(1340)

173

(1680)
(1680)

175

(1700)

Λ
91/1

Λ
78

213/1

φ 210/1

Λ
80/1

Λ
115/2

Λ
95/1

φ 210/1

Λ 80/1

91/7

Λ 91/5

91/3

91/6

213/1



Λ 95/1

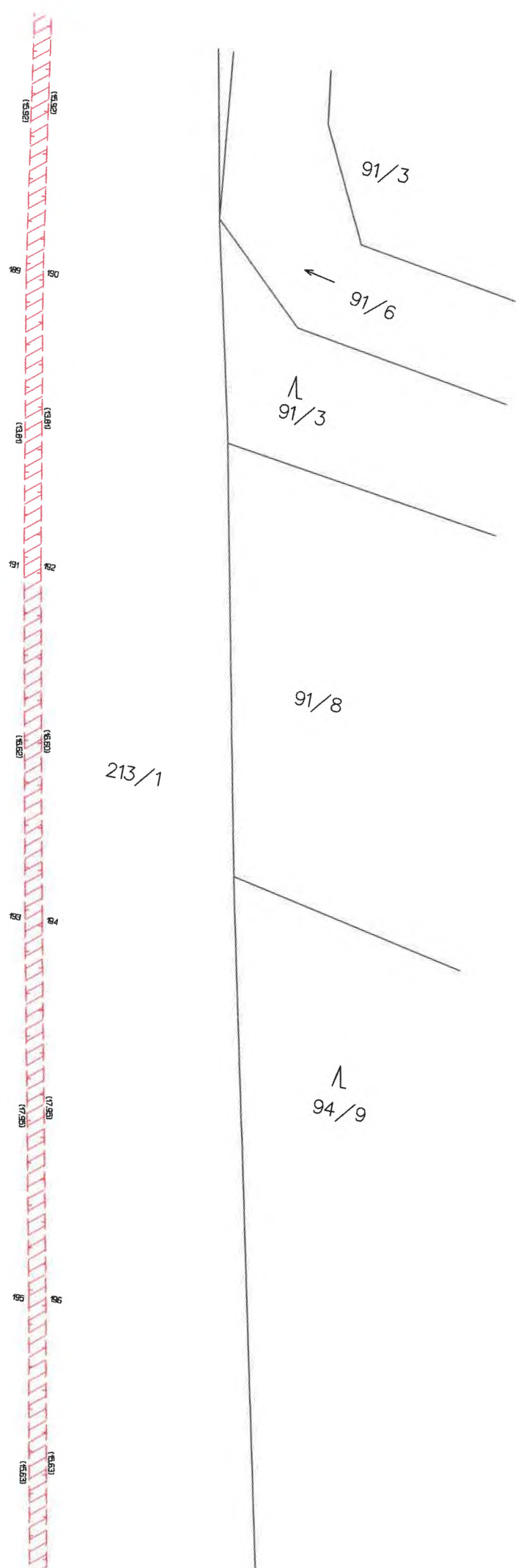
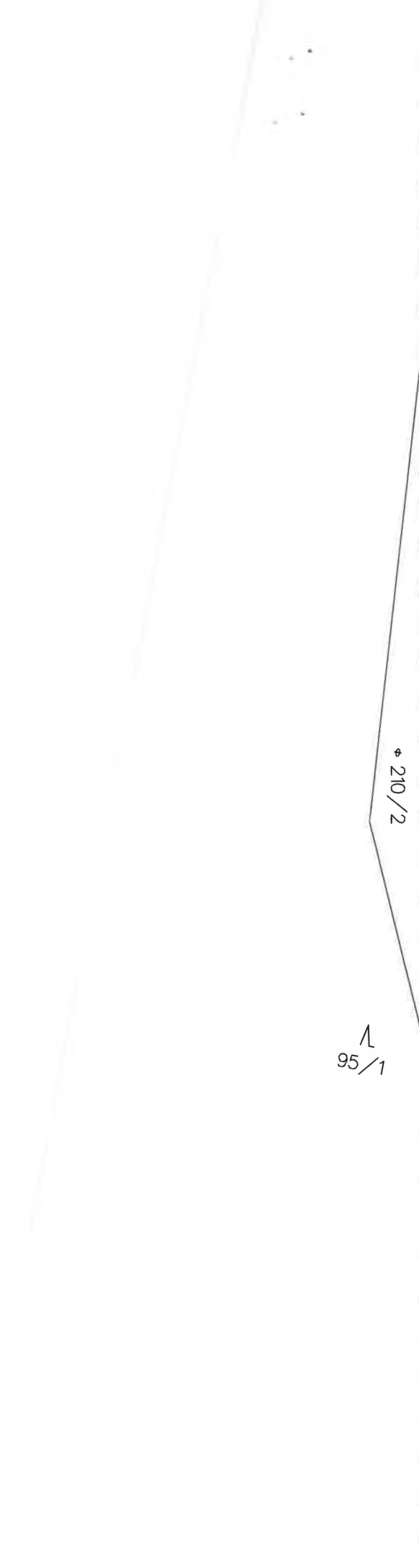

(16.82) 85
(16.87) 85
(16.81) 87
(16.87) 87
(16.80) 86
(16.87) 86
(17.50) 86
(17.50) 86
(16.53) 86
(16.53) 86

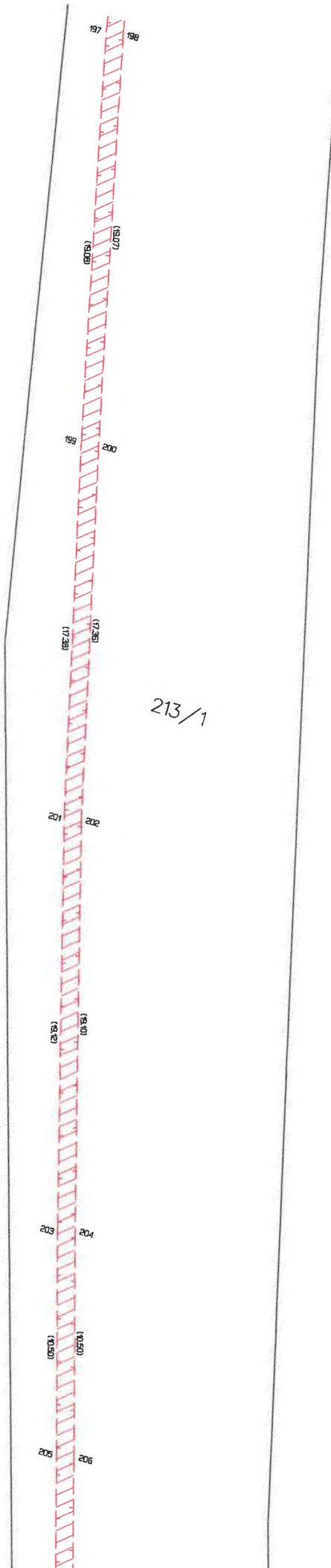

197

(1907)
(1908)

199 200

(1738)
(1739)

202 203

(1840)
(1841)

204 205

(1950)
(1951)

206 207

∟
94/9

213/1

∟
95/1

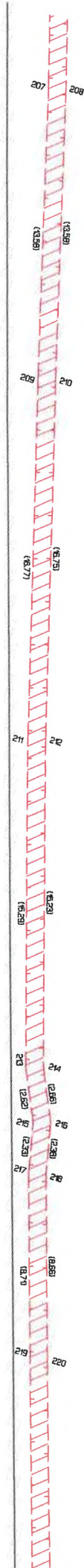

Λ
95/1

213/1

Λ
94/9

91/4

92/4



∟
95/1

∟
94/1

213/1

1
94/1

1
95/1

213/1

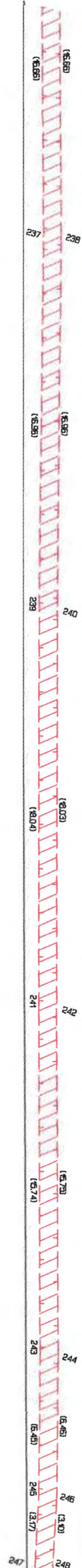

(1488) (1488)
R R
(1443) (1443)
R R
(1454) (1454)
R R
(1423) (1423)
R R
(1423) (1423)
R R

∟
95/1

213/1

∟
94/1



∧
95/1

213/1

∧
94/1

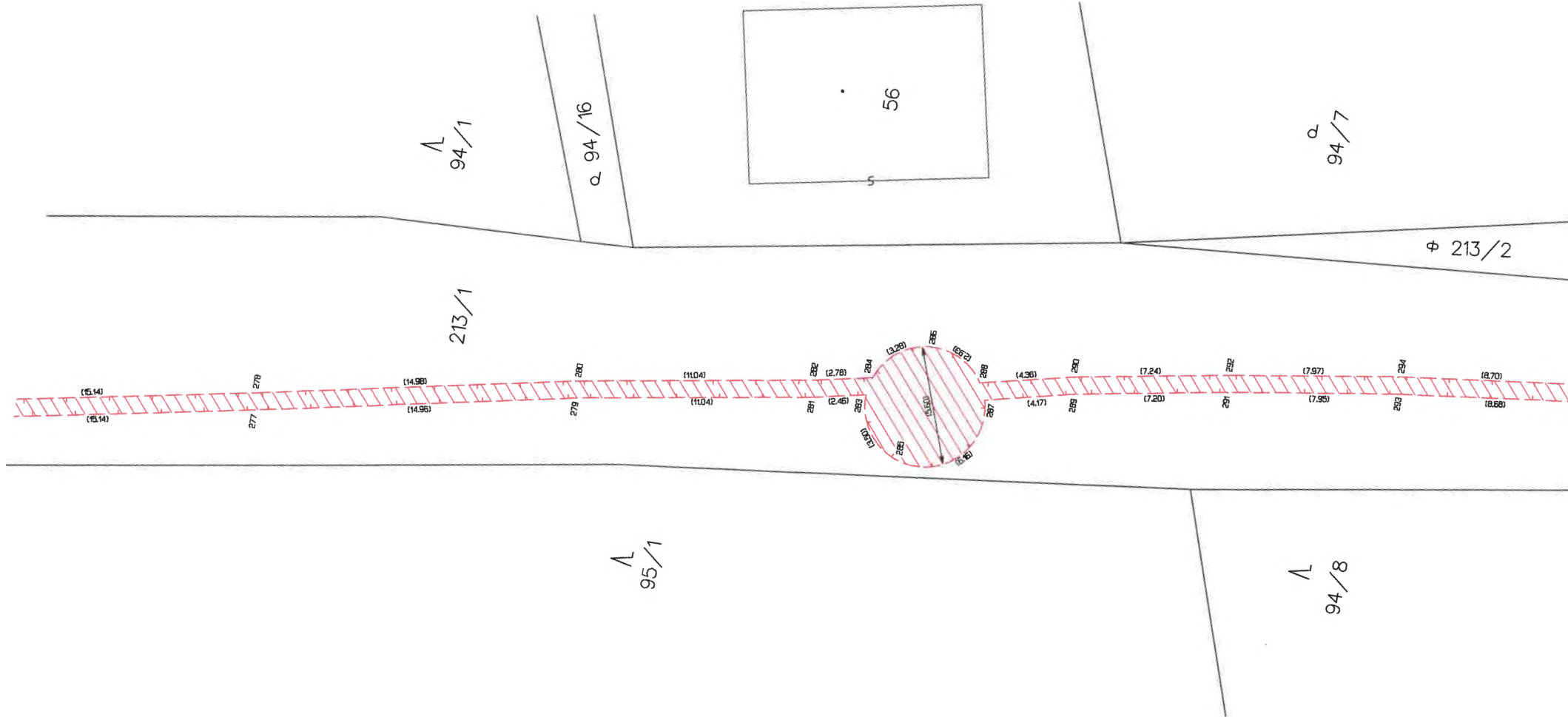

22

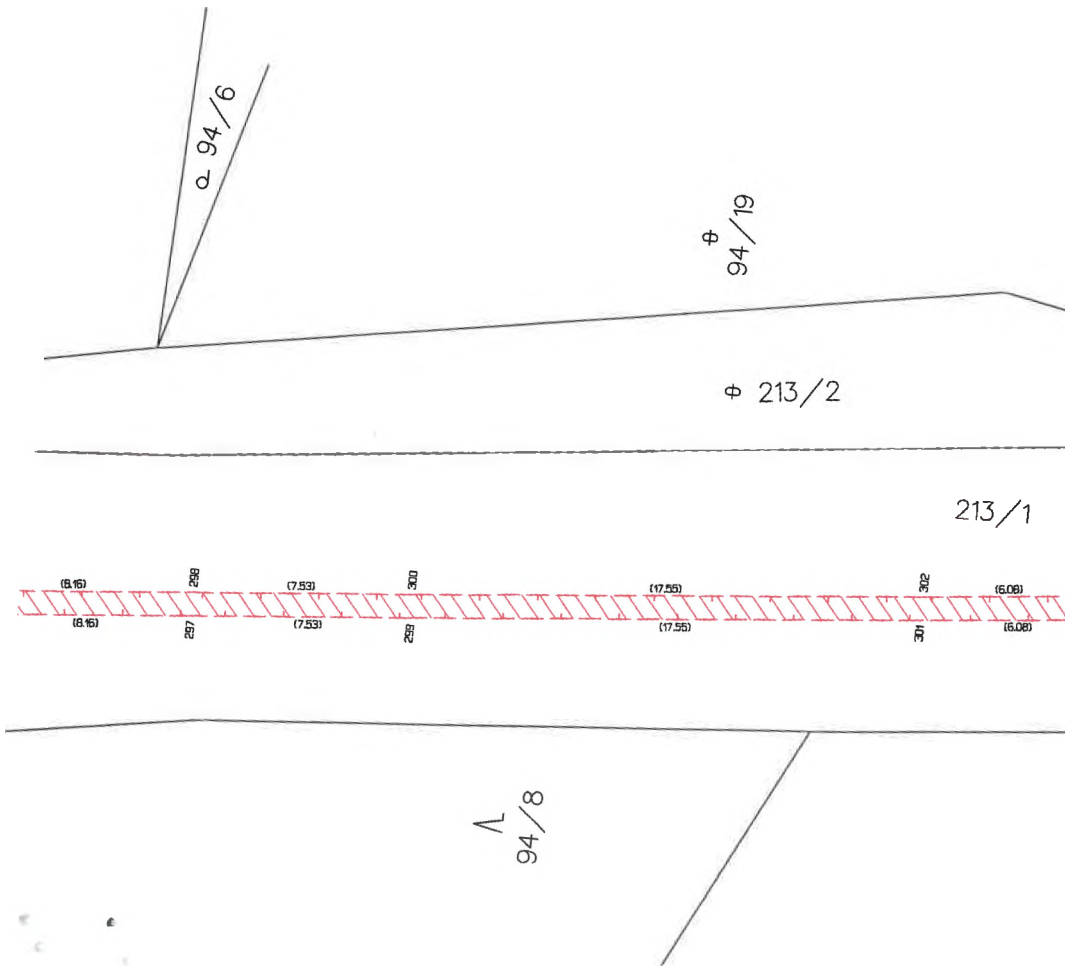

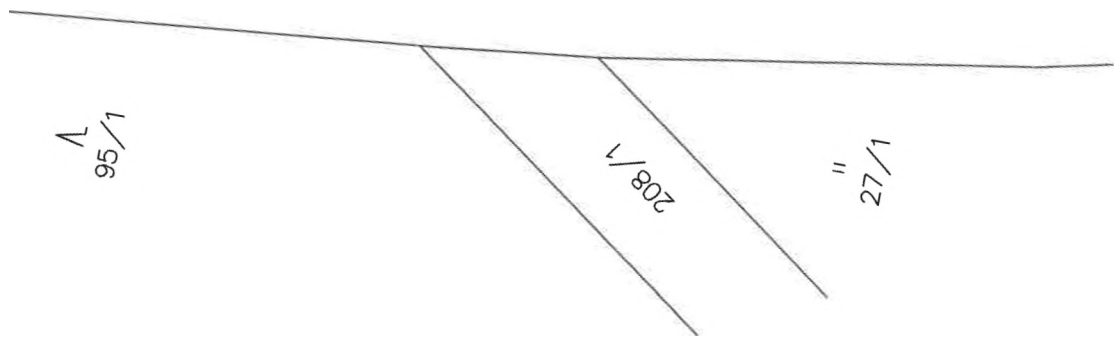
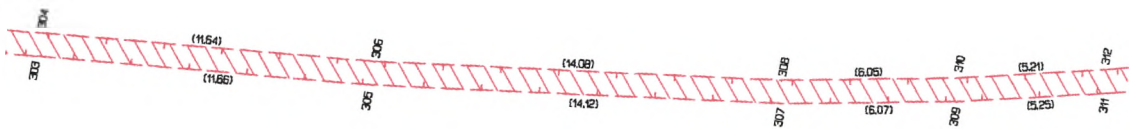

L
95/1

208/1

"
27/1

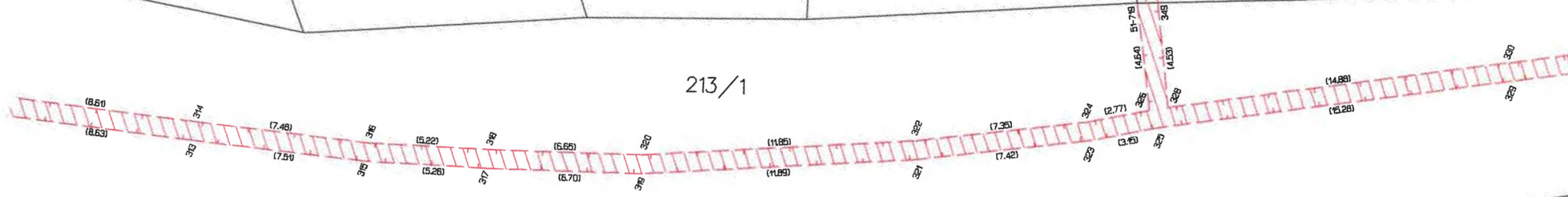

27/1

