

Příloha č. 4 – Výkresová dokumentace konečných výrobků

Výkres č.	Název výkresu	Výrobce PS	Typ PS	Výkres (soubor PDF)
3-678-654-000	Rovný díl 1200mm	Schindler	9300	 Schi 9300_3-678-654-000
3-678-655-000	Rovný díl 1800mm	Schindler	9300	 Schi 9300_3-678-655-000
3-678-656-000	Rovný díl 2400mm	Schindler	9300	 Schi 9300_3-678-656-000
3-678-657-000	Rovný díl 3000mm	Schindler	9300	 Schi 9300_3-678-657-000
3-678-658-000	Rovný díl 2270mm	Schindler	9300	 Schi 9300_3-678-658-000
3-678-659-000	Oblouk horní pravý	Schindler	9300	 Schi 9300_3-678-659-000
3-678-660-000	Oblouk horní levý	Schindler	9300	 Schi 9300_3-678-660-000
3-678-661-000	Oblouk dolní levý	Schindler	9300	 Schi 9300_3-678-661-000
3-678-662-000	Oblouk dolní pravý	Schindler	9300	 Schi 9300_3-678-662-000
3-678-663-000	Koncový díl	Schindler	9300	 Schi 9300_3-678-663-000
3-678-664-000	Koncový díl I.	Schindler	9300	 Schi 9300_3-678-664-000
3-4678-662-000	Oblouk dolní pravý	Schindler	9300	 Schi 9300_3-4678-662-00

PŘÍLOHA č. 4
Smlouvy

3-678-665-000	Rovný díl 1200mm	Schindler	SWT, EWH, EWE	 Schi EWE;EWH;SWT_3-678
3-678-666-000	Rovný díl 1800mm	Schindler	SWT, EWH, EWE	 Schi EWE;EWH;SWT_3-678
3-678-667-000	Rovný díl 2400mm	Schindler	SWT, EWH, EWE	 Schi EWE;EWH;SWT_3-678
3-678-668-000	Rovný díl 3000mm	Schindler	SWT, EWH, EWE	 Schi EWE;EWH;SWT_3-678
3-678-669-000	Rovný díl 2270mm	Schindler	SWT, EWH, EWE	 Schi EWE;EWH;SWT_3-678
3-678-670-000	Oblouk horní levý	Schindler	SWT, EWH, EWE	 Schi EWE;EWH;SWT_3-678
3-678-671-000	Oblouk horní pravý	Schindler	SWT, EWH, EWE	 Schi EWE;EWH;SWT_3-678
3-678-672-000	Oblouk dolní levý	Schindler	SWT, EWH, EWE	 Schi EWE;EWH;SWT_3-678
3-678-673-000	Oblouk dolní pravý	Schindler	SWT, EWH, EWE	 Schi EWE;EWH;SWT_3-678
3-678-674-000	Koncový díl	Schindler	SWT, EWH, EWE	 Schi EWE;EWH;SWT_3-678
3-678-675-000	Koncový díl I.	Schindler	SWT, EWH, EWE	 Schi EWE;EWH;SWT_3-678

26

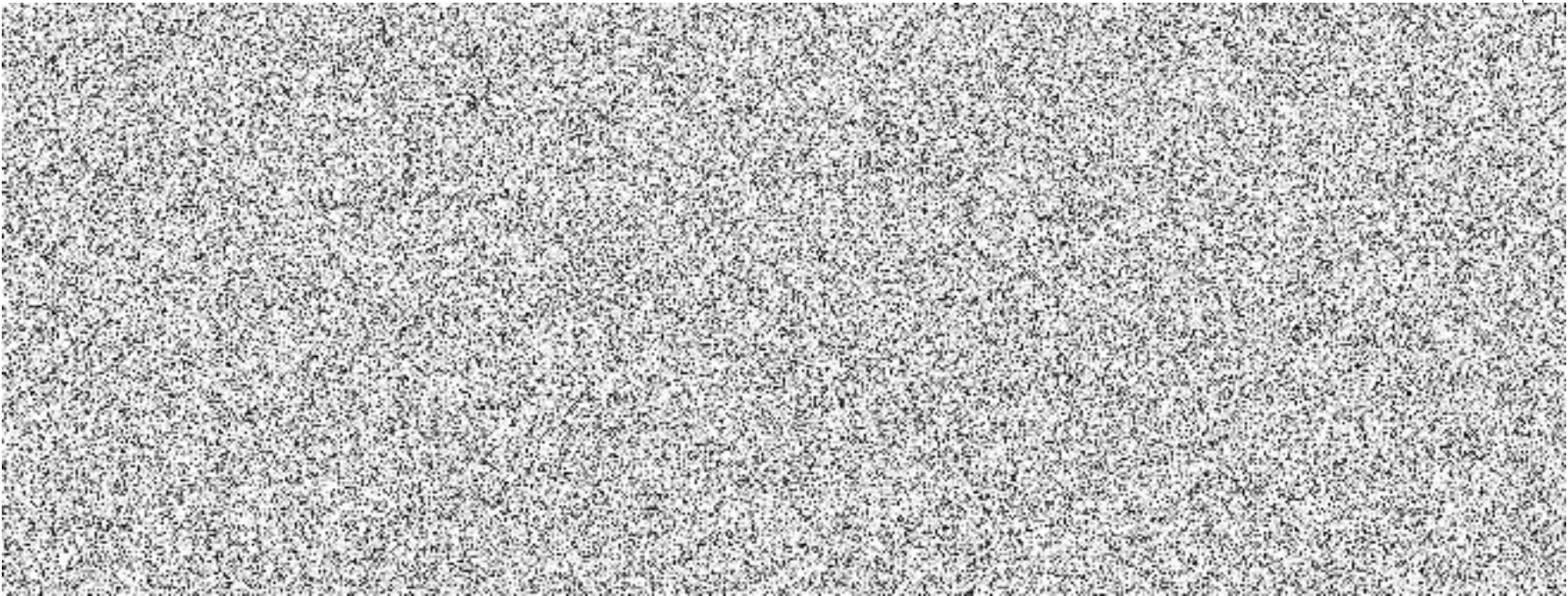
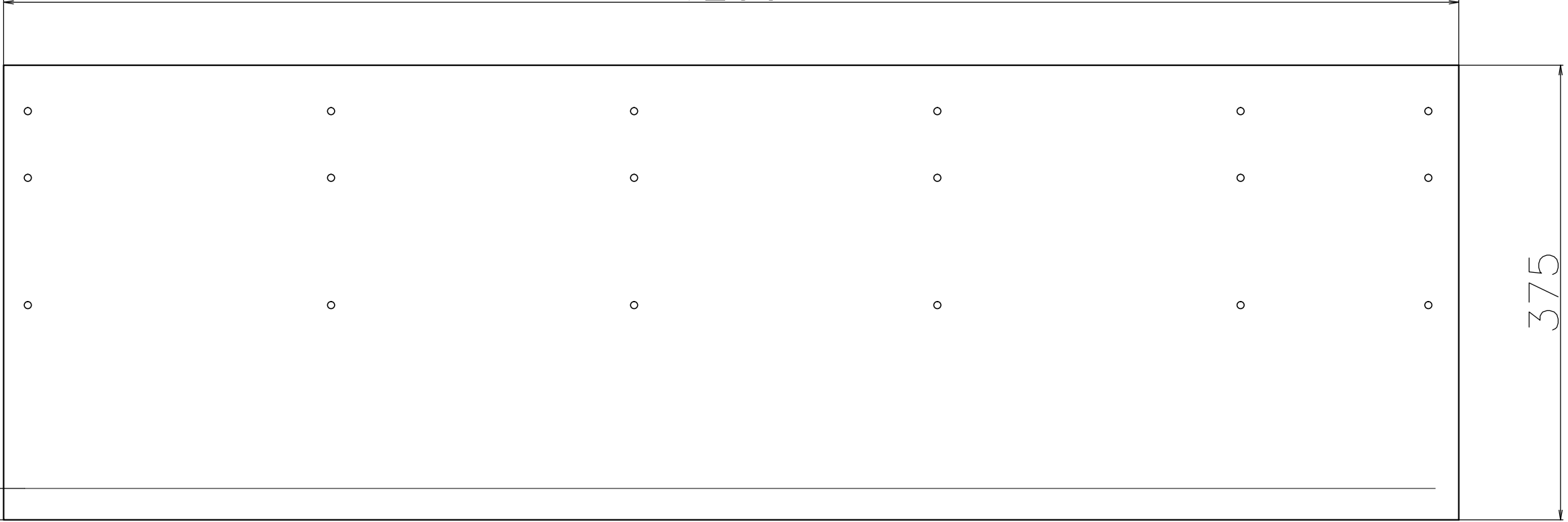

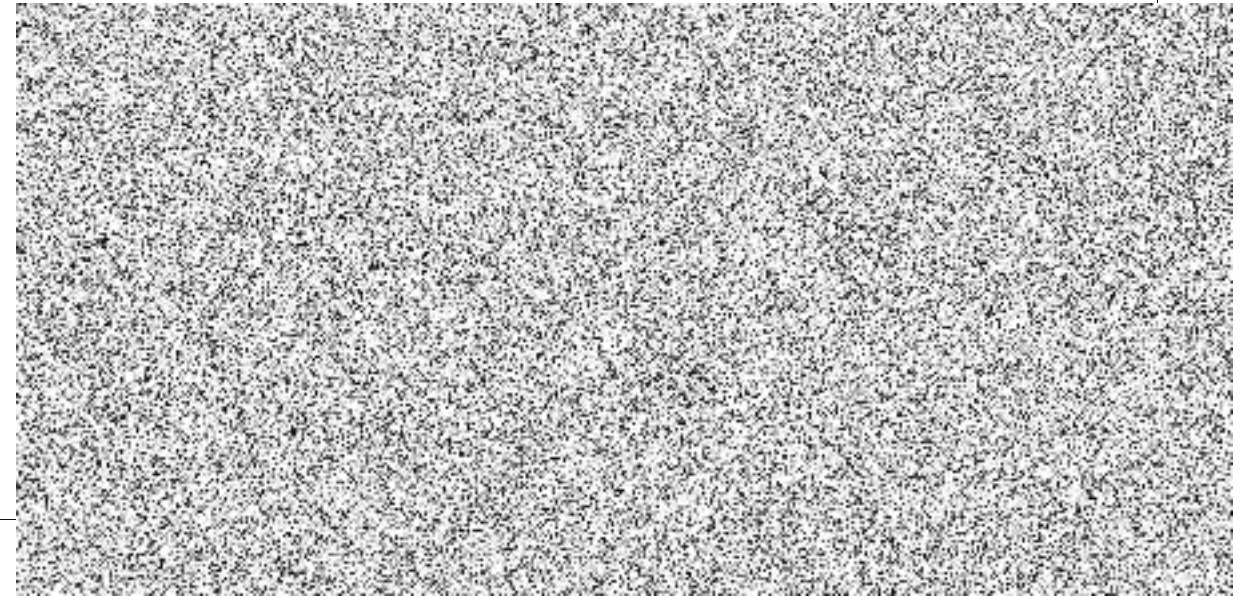
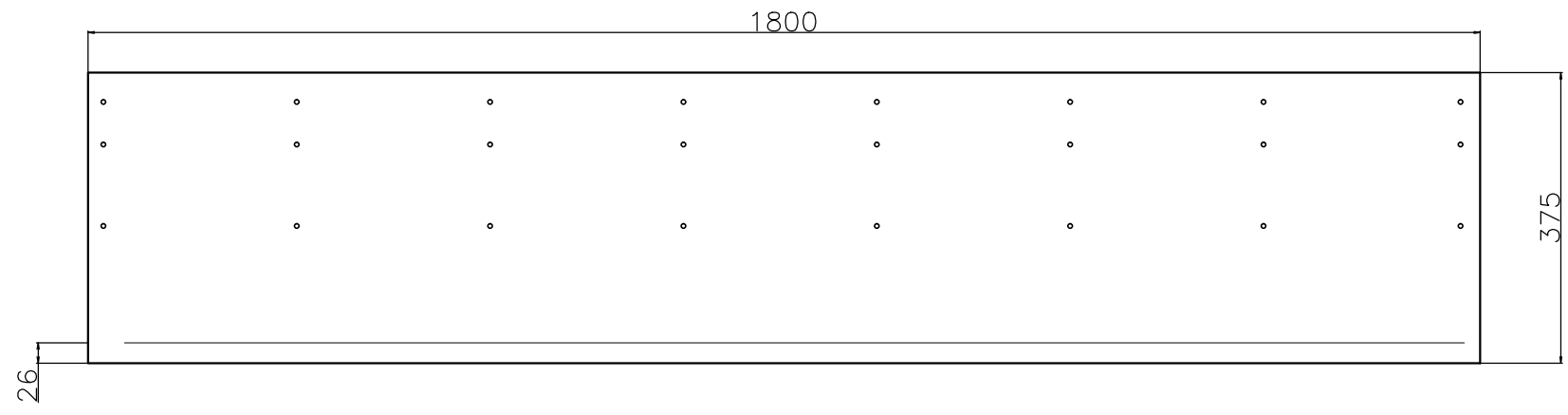

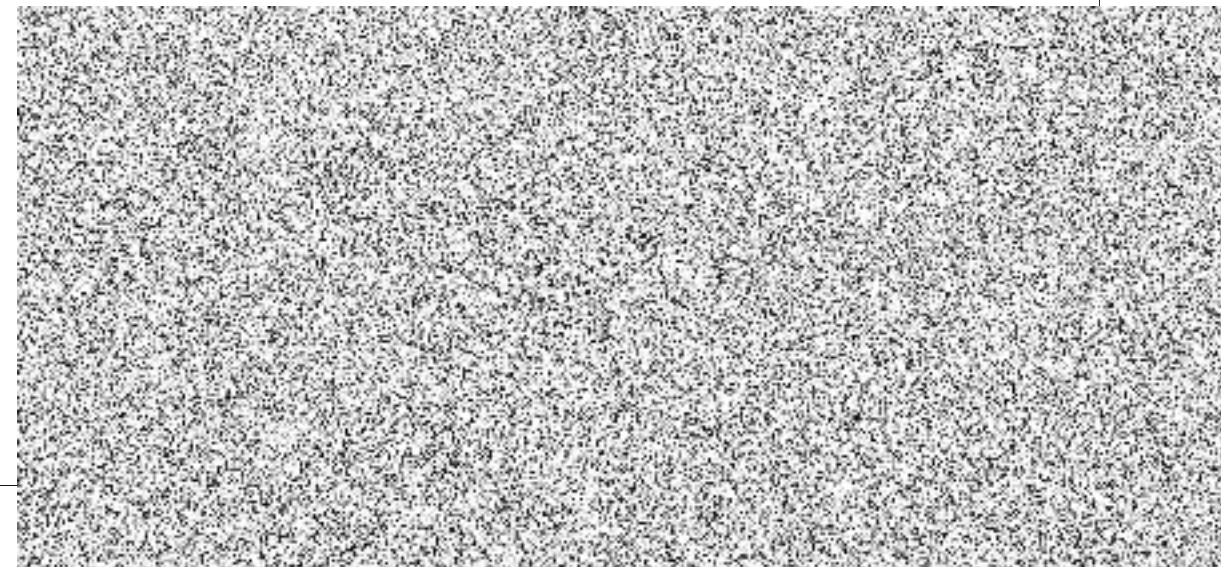
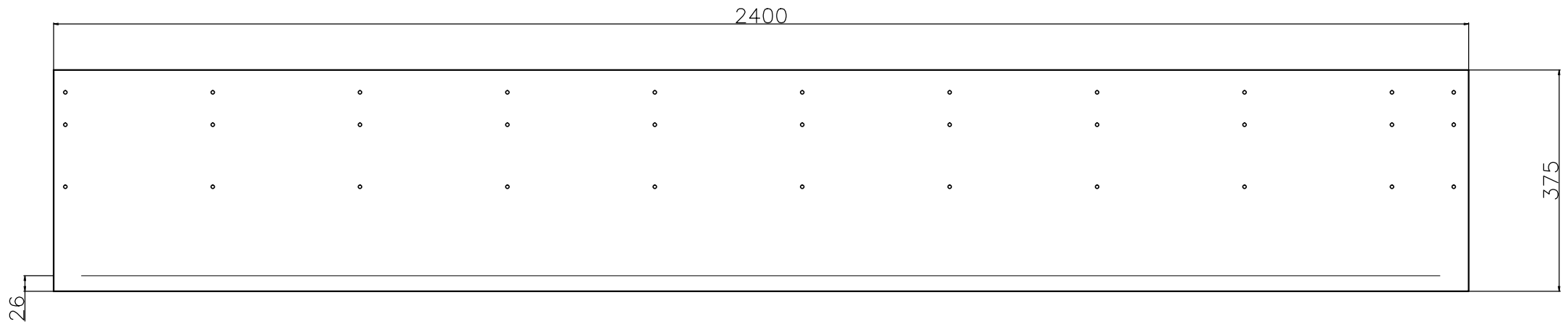

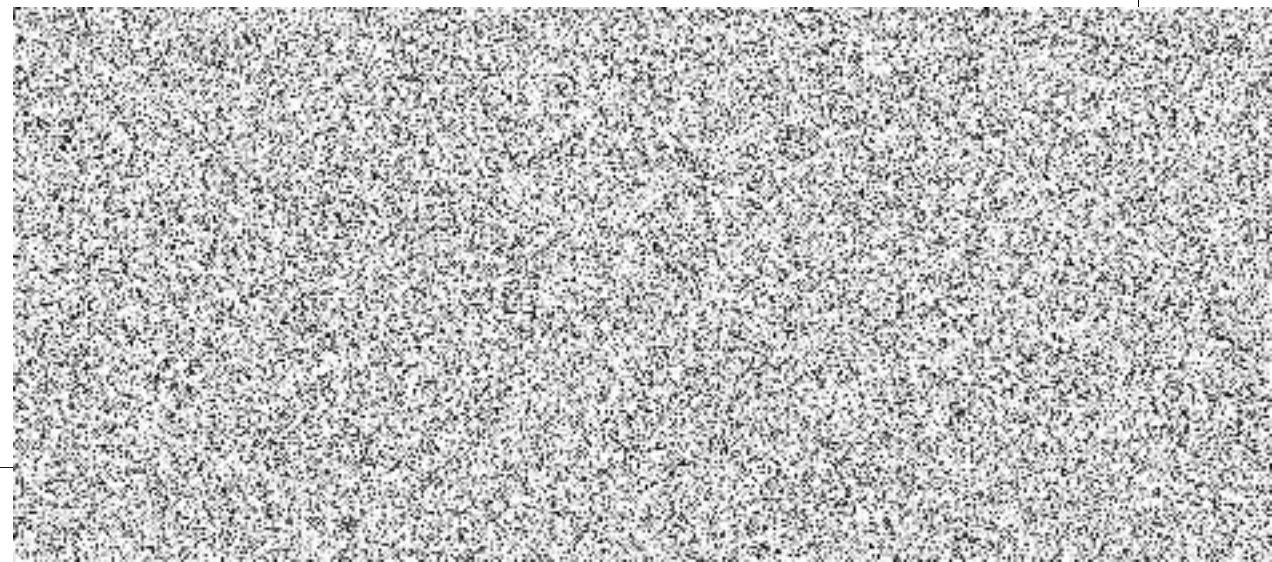
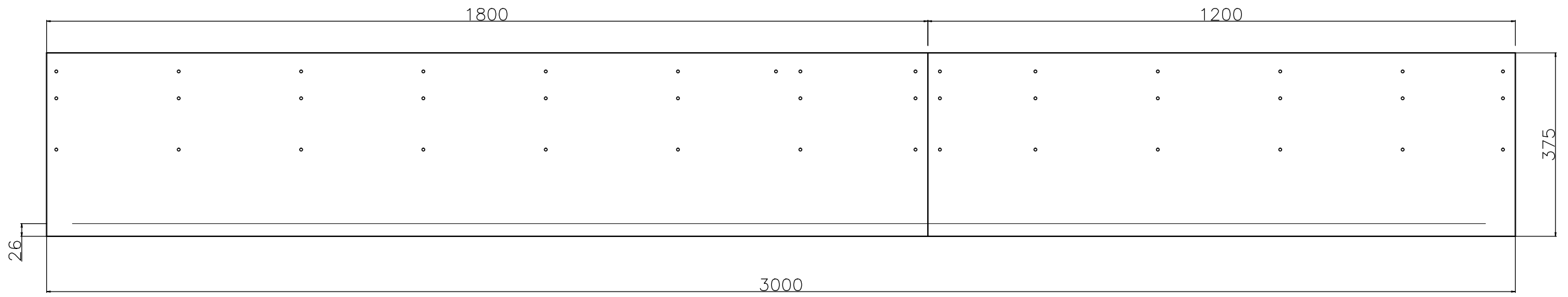

2270

375

26

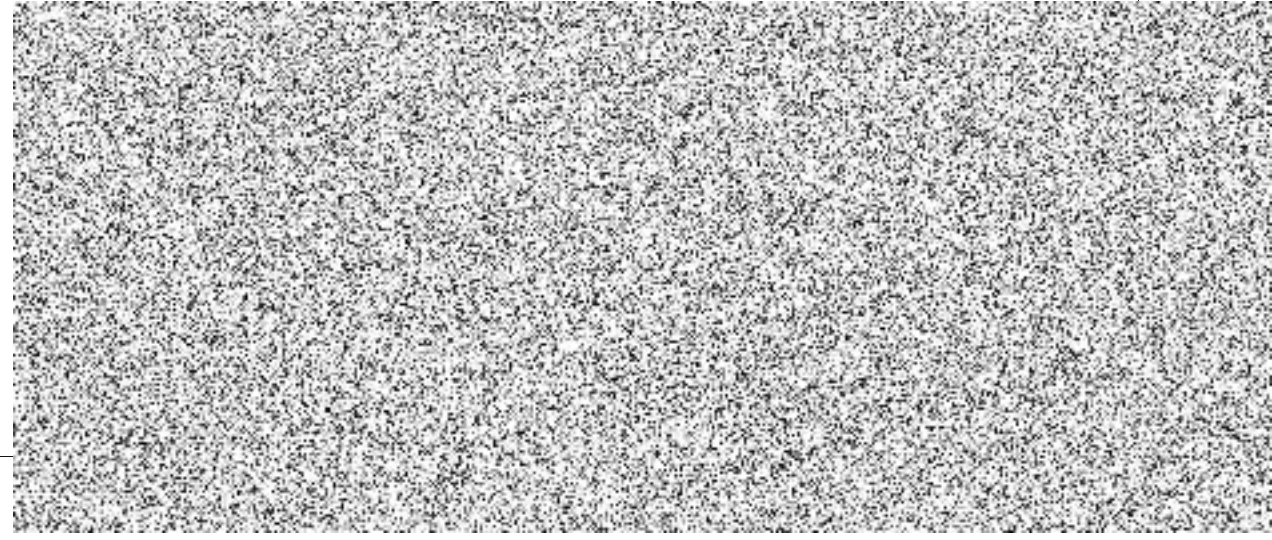
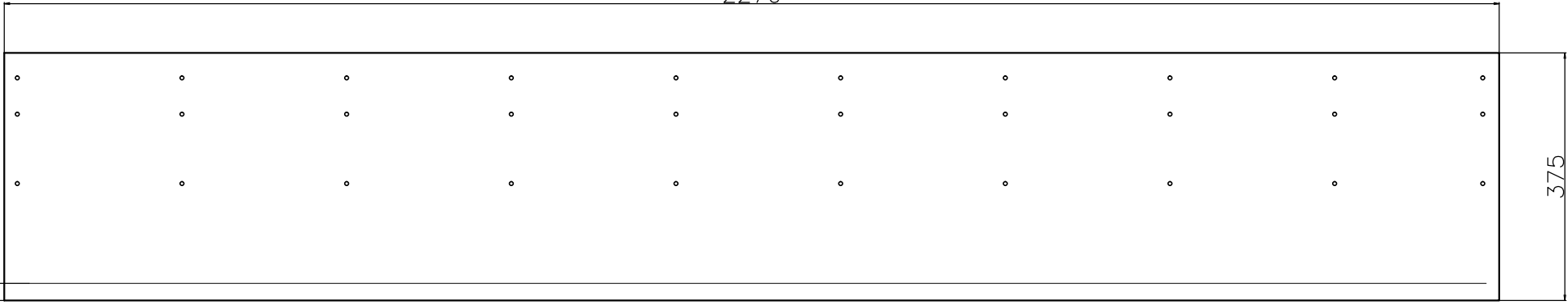

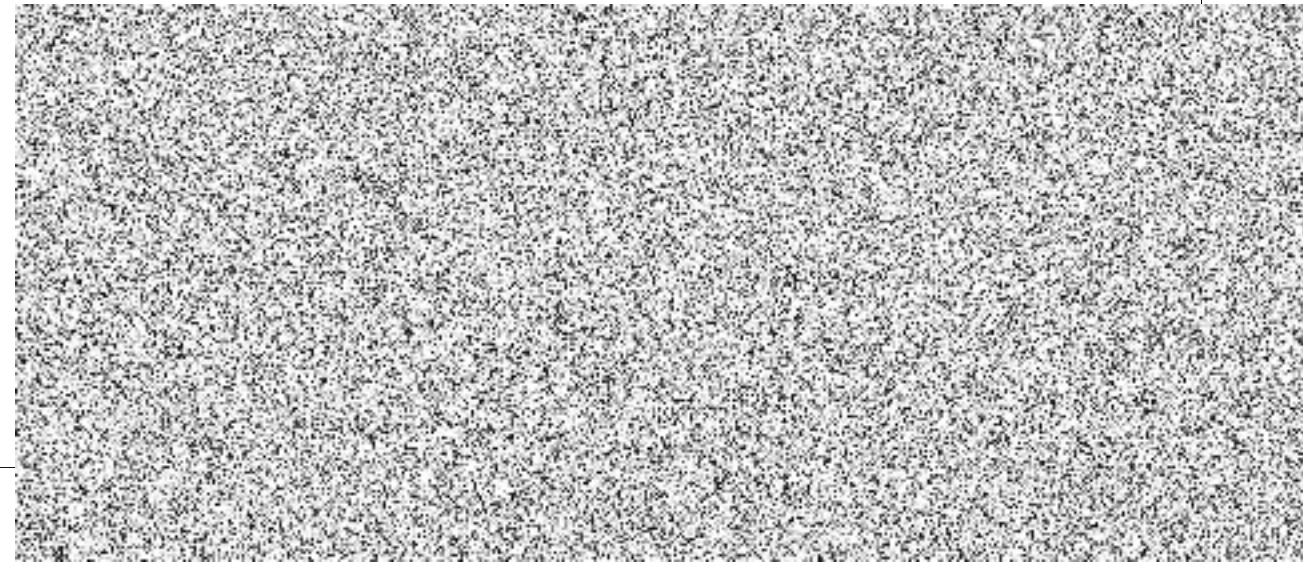
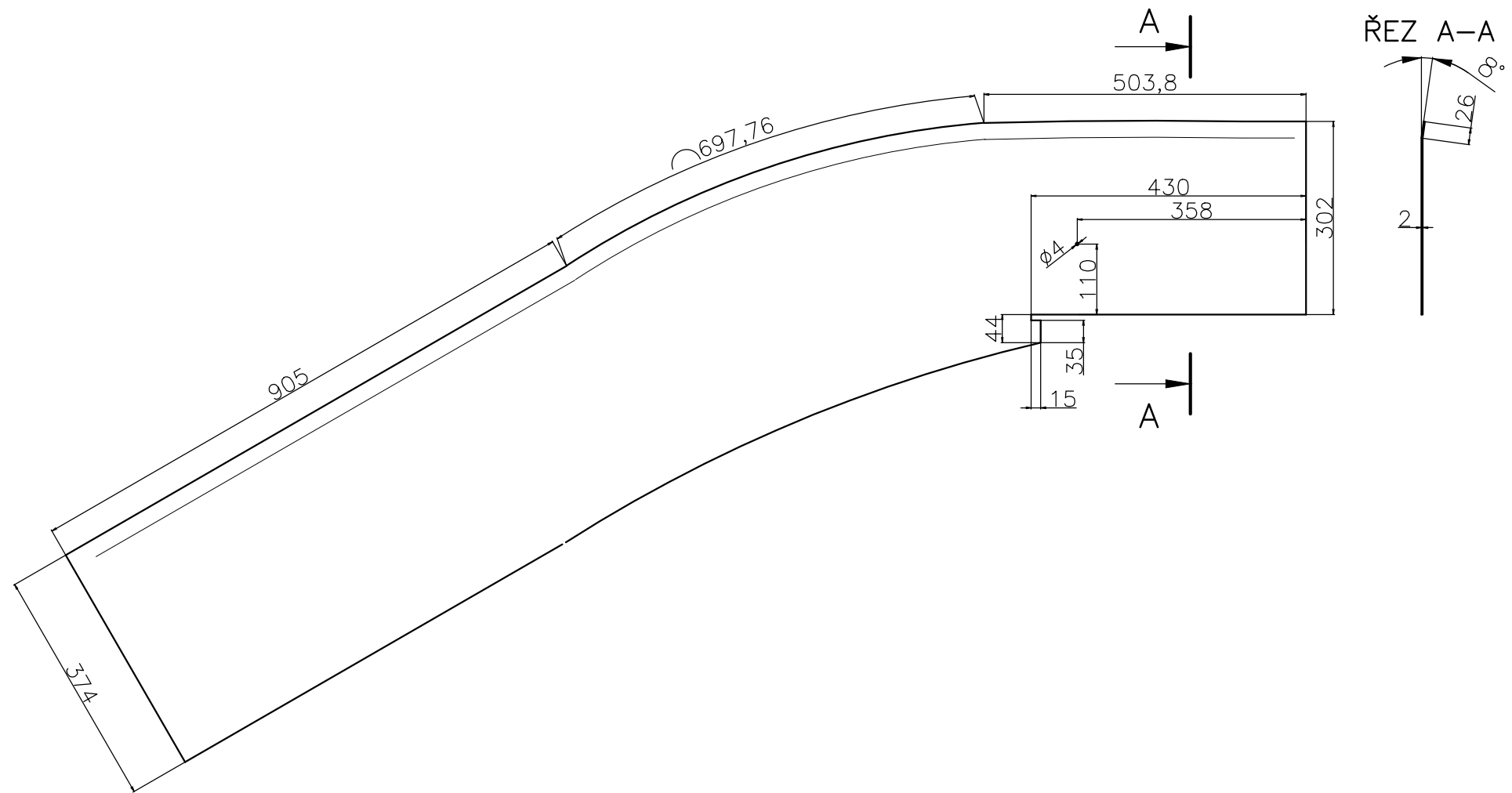

ŘEZ A-A

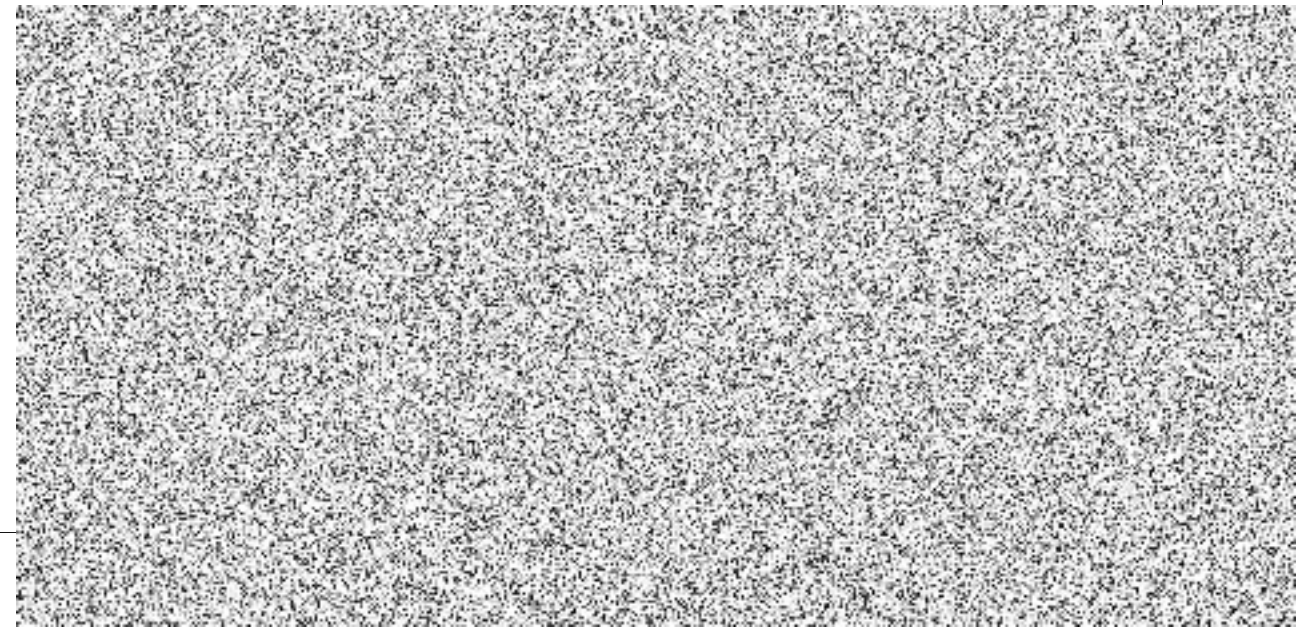
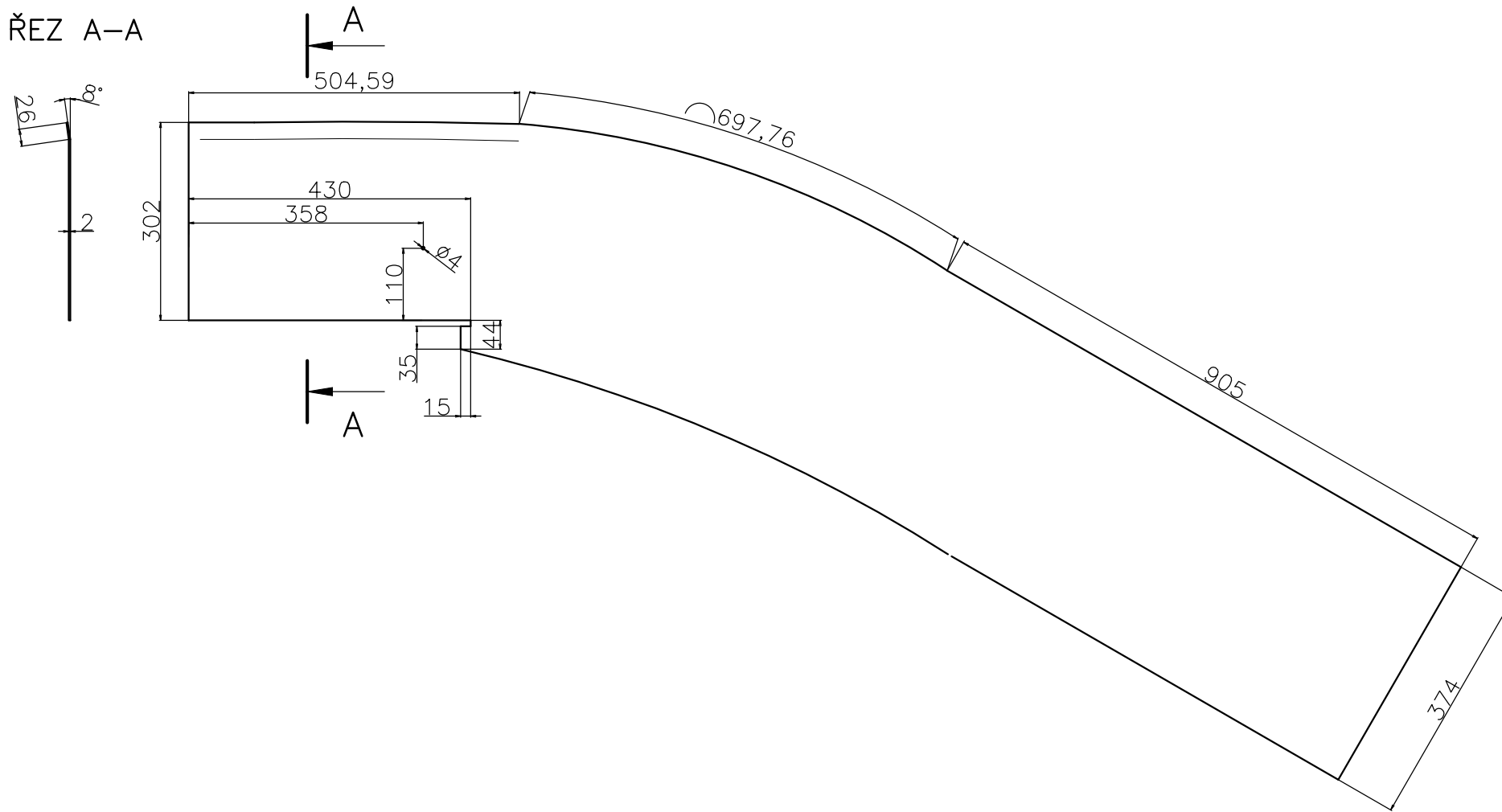

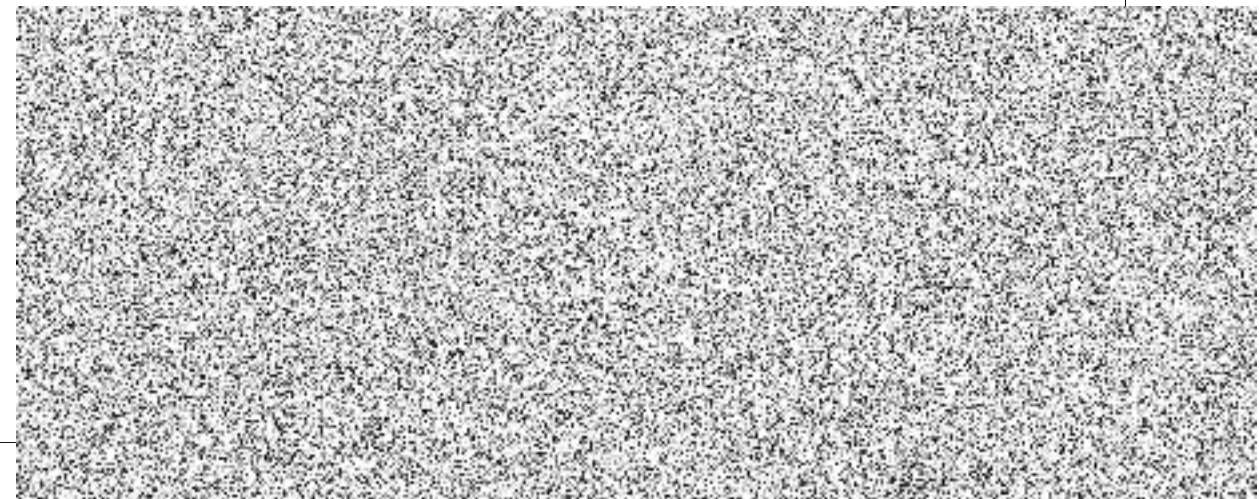
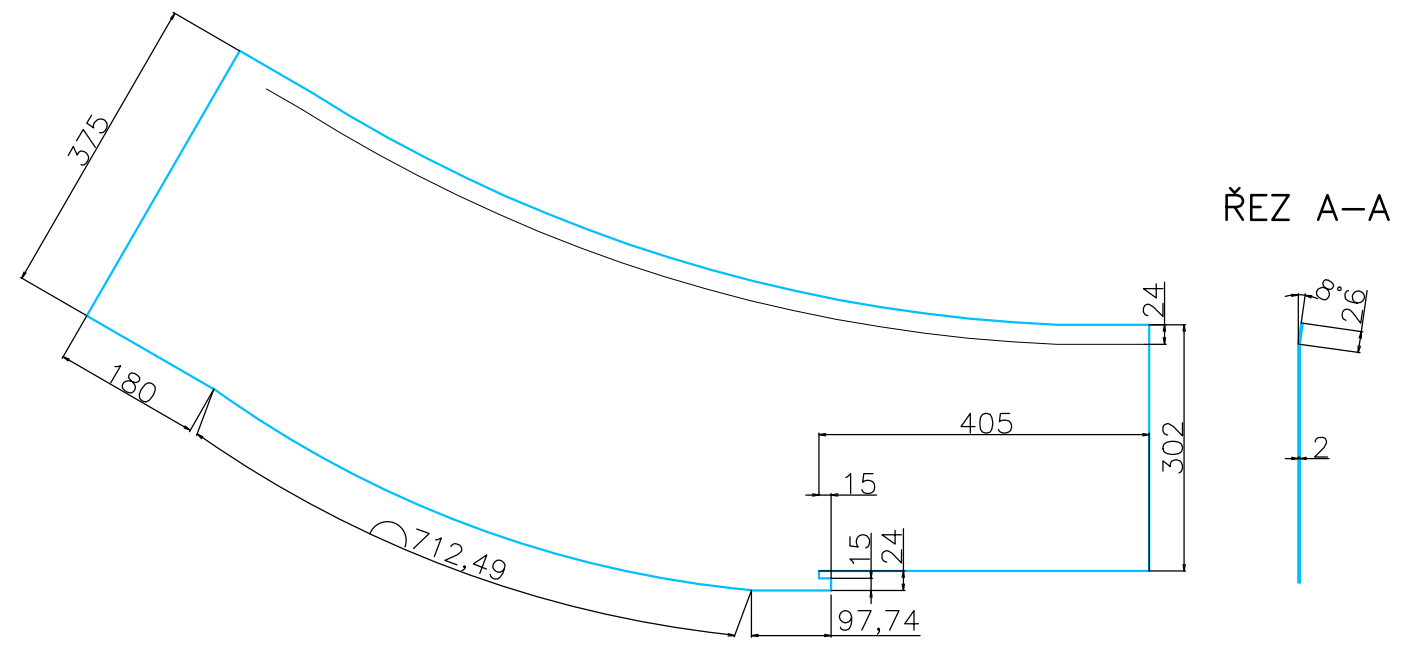

ŘEZ A-A

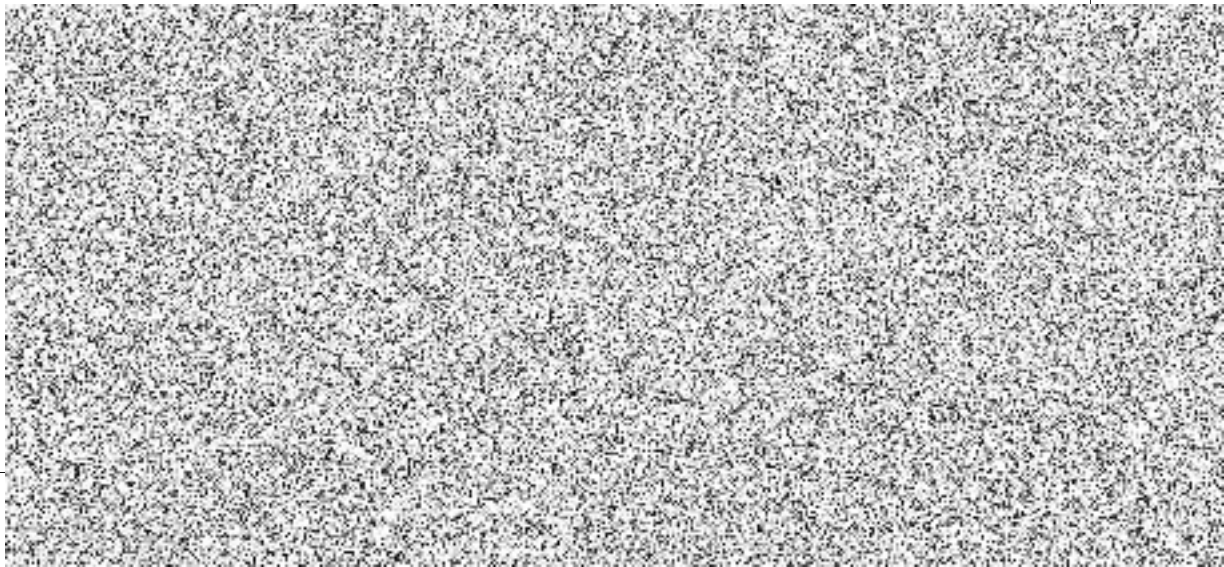
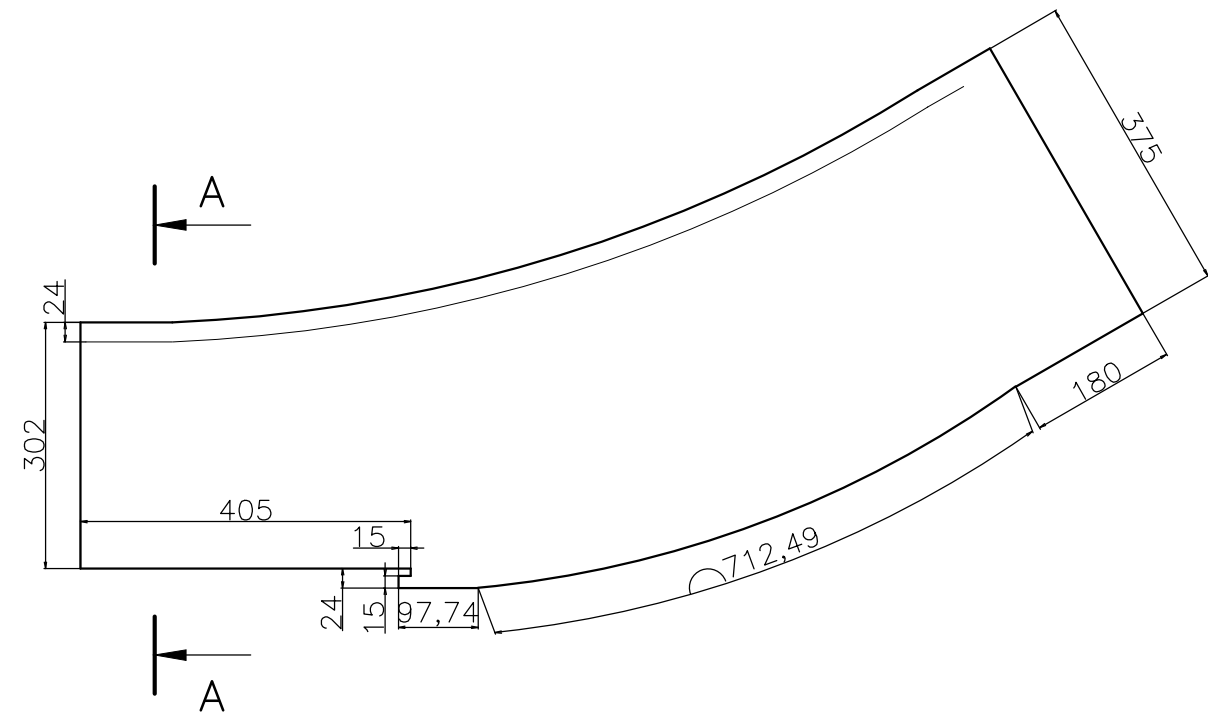
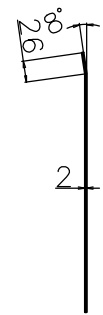

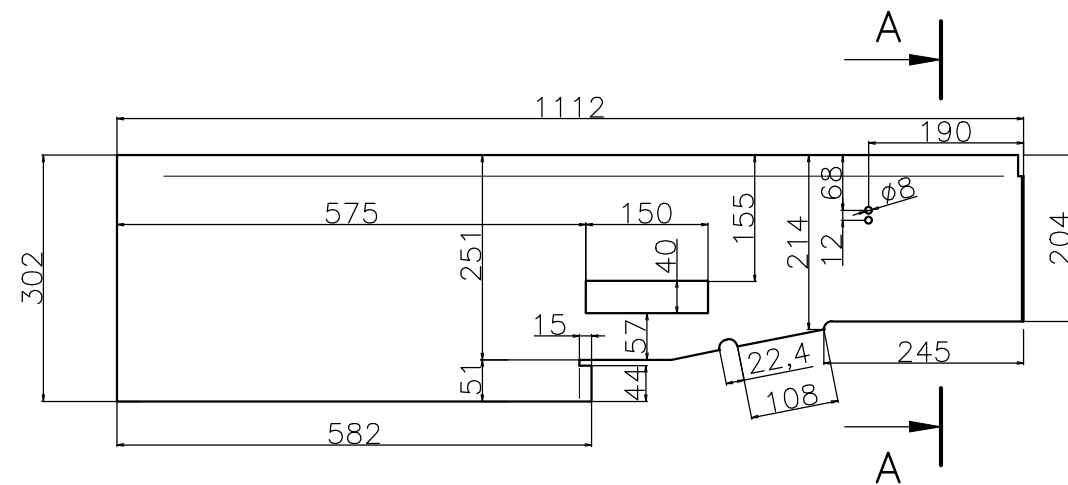

ŘEZ A-A

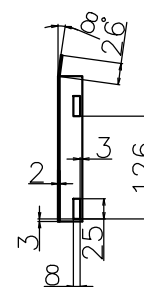

ŘEZ B-B

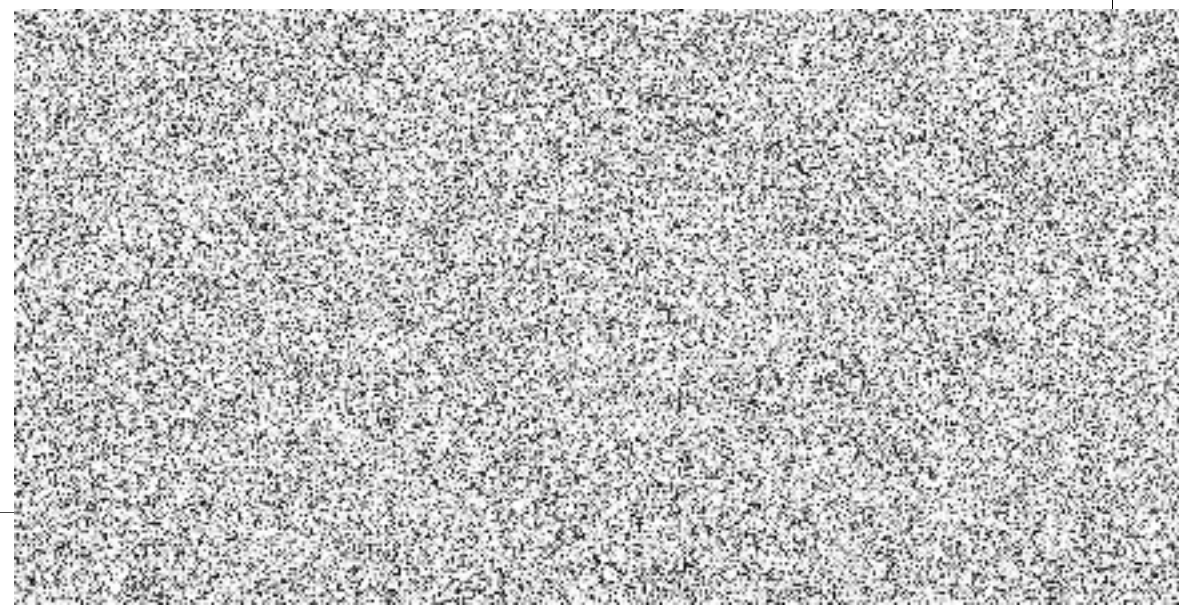
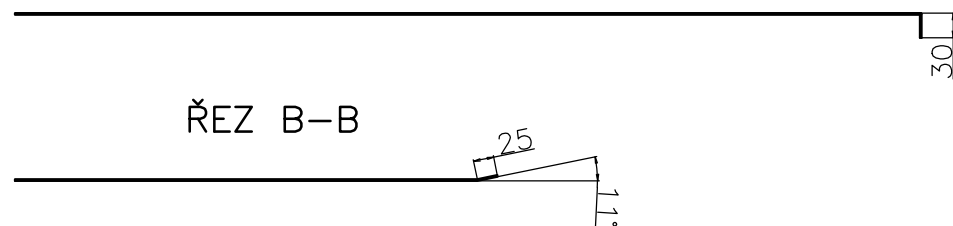

ŘEZ A-A

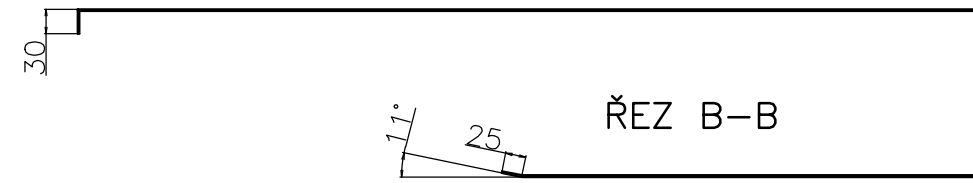
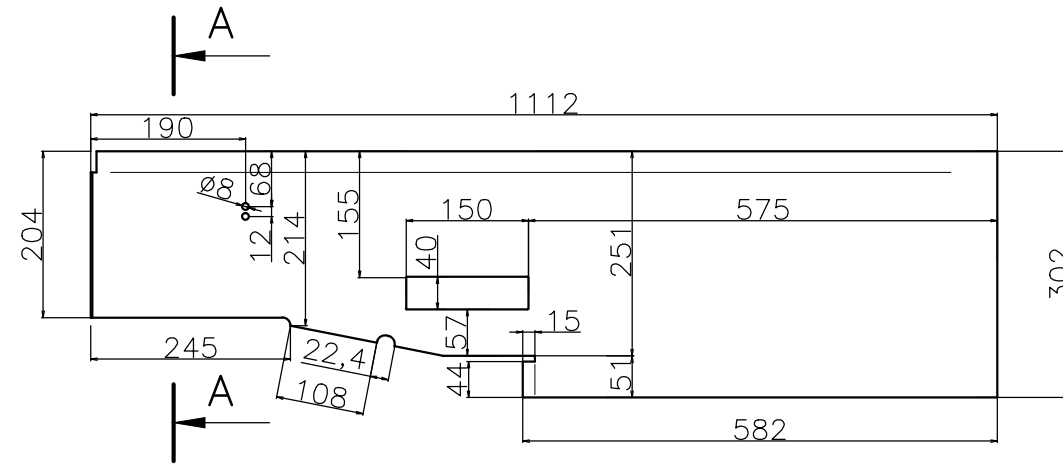
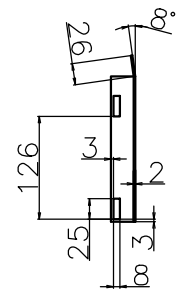

ŘEZ B-B

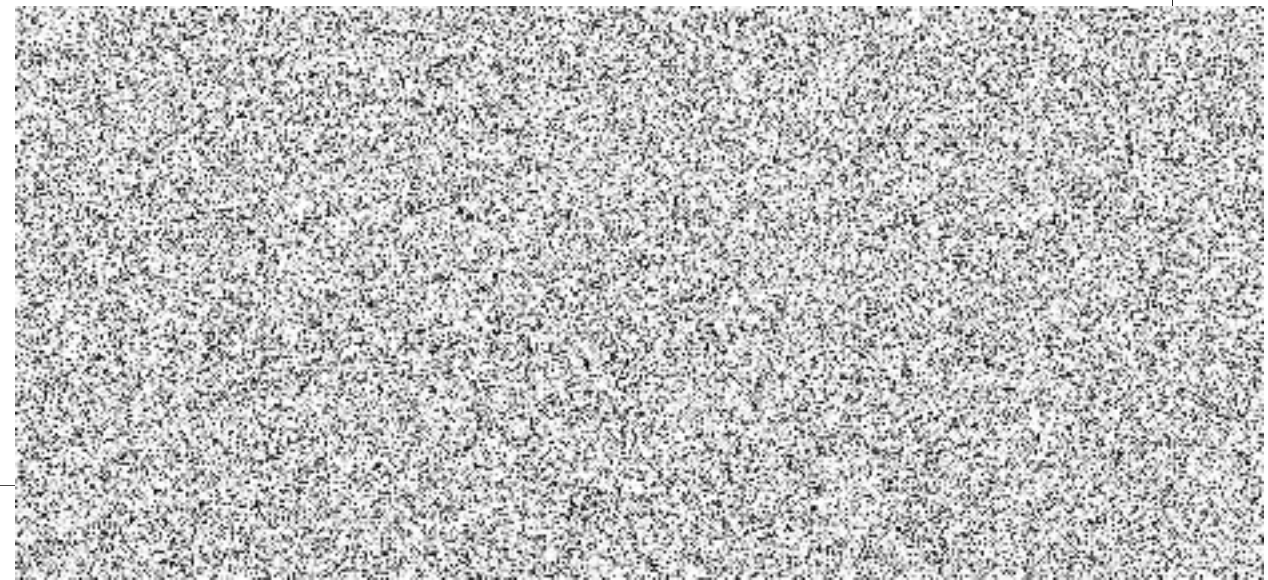

ŘEZ A-A

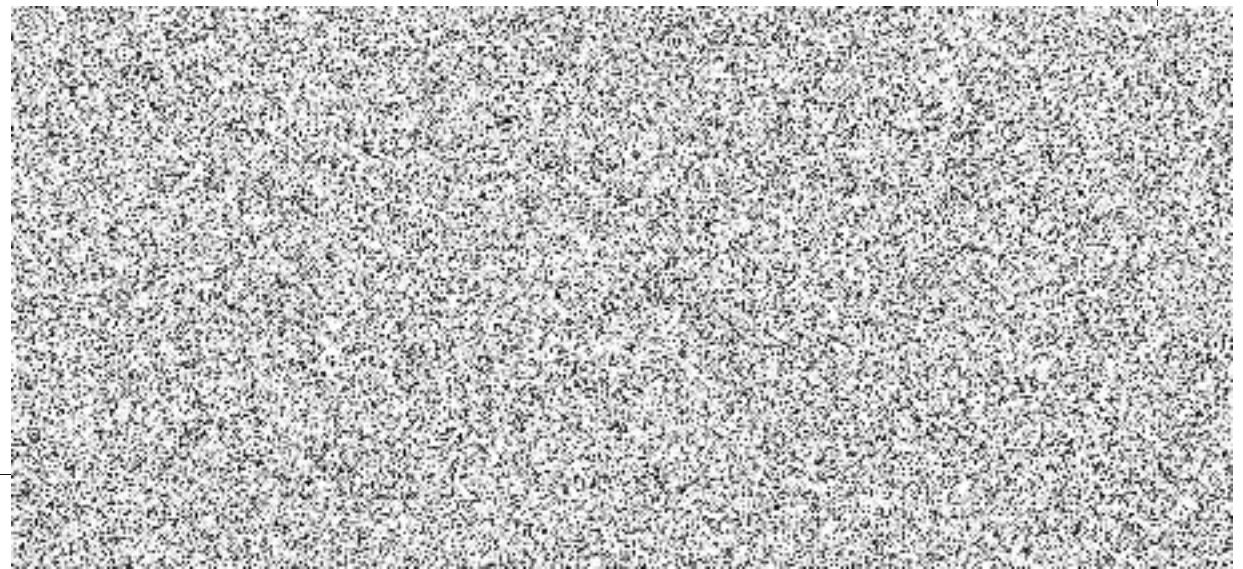
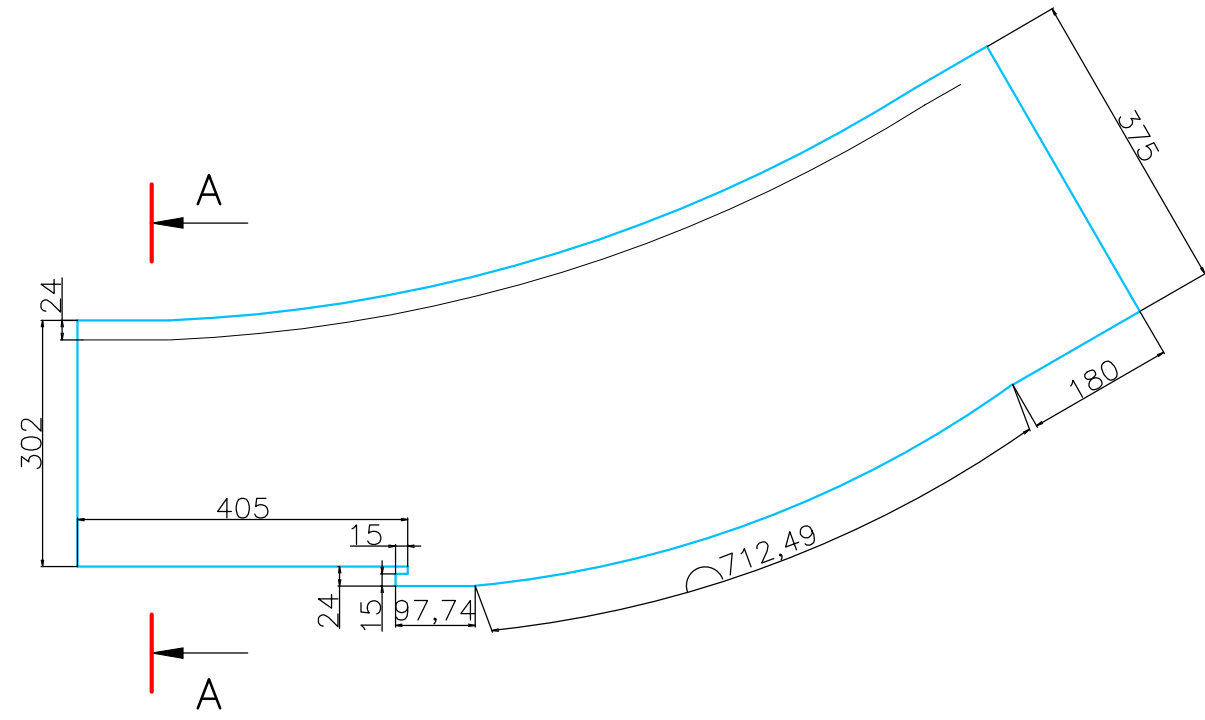
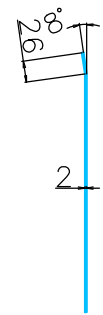

1200

298

26

