

1 1a

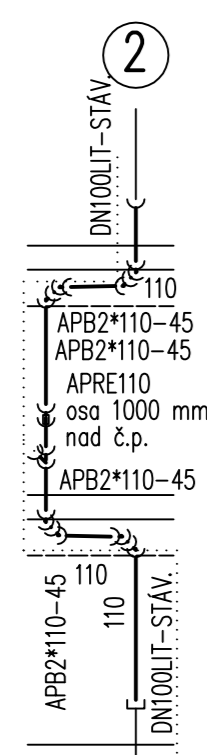

2

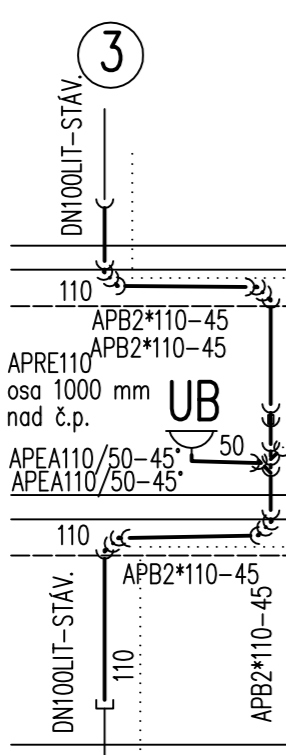

3

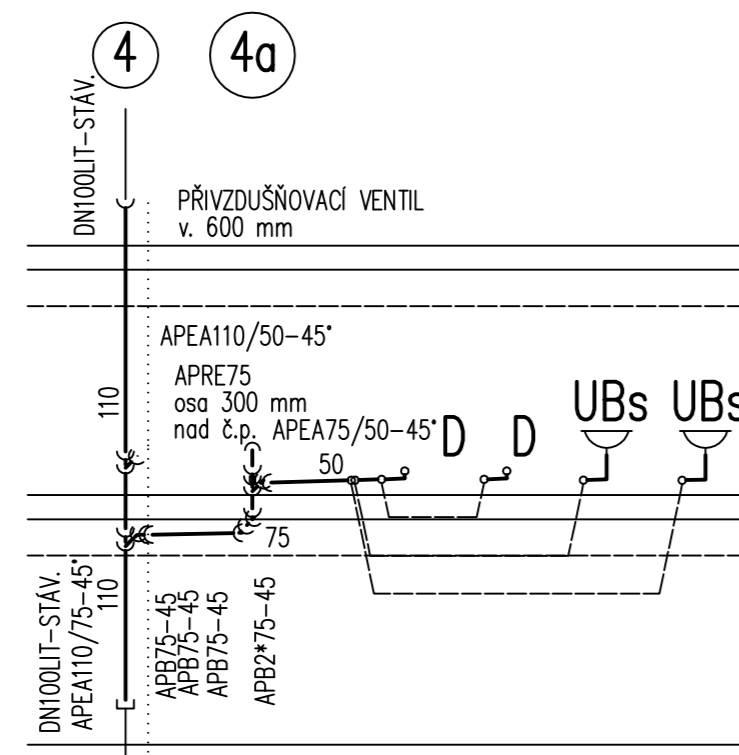

4 4a

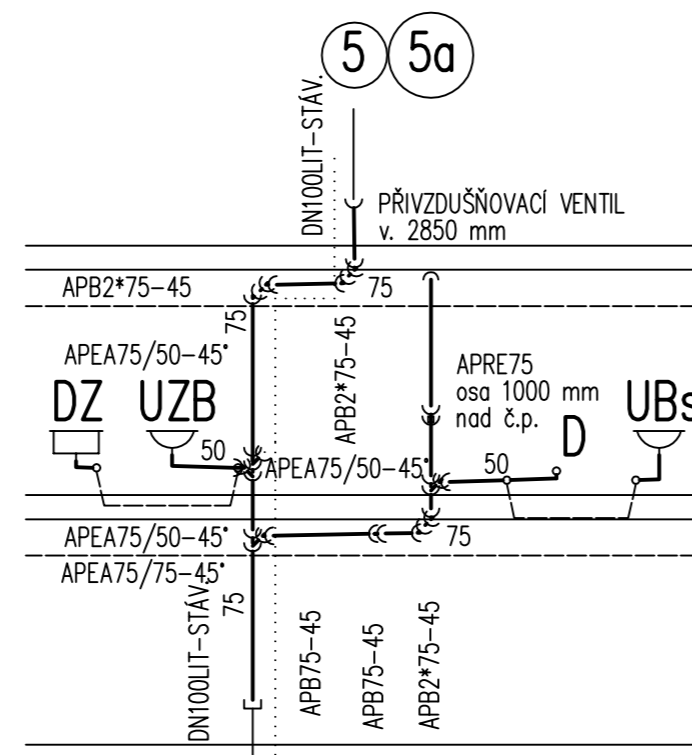

5 5a

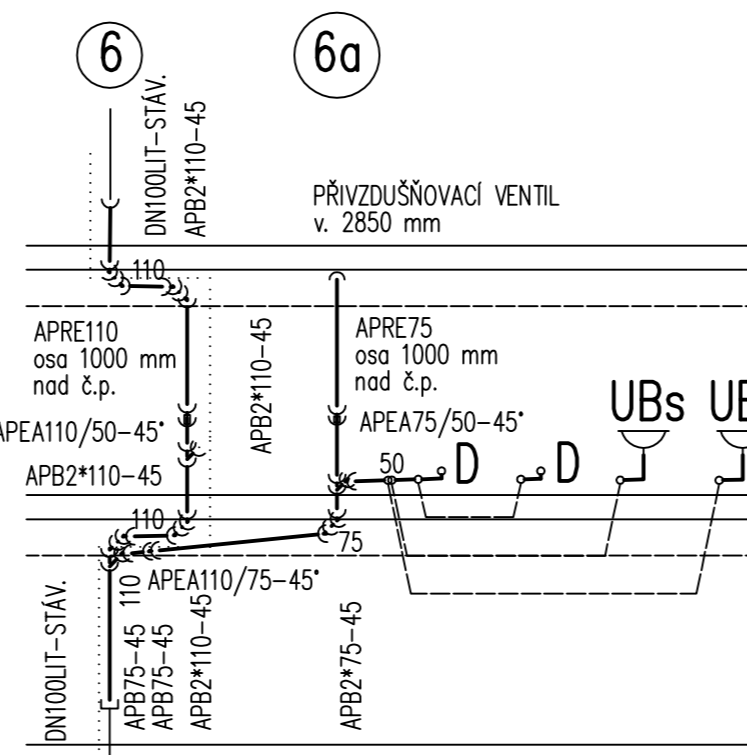

6 6a

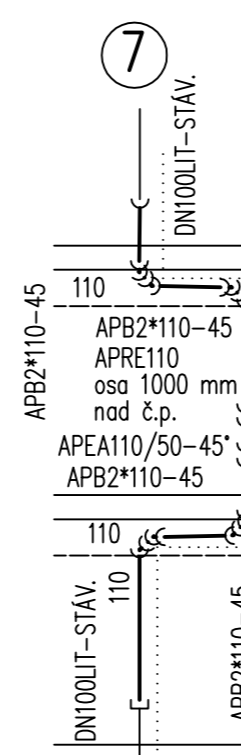

7

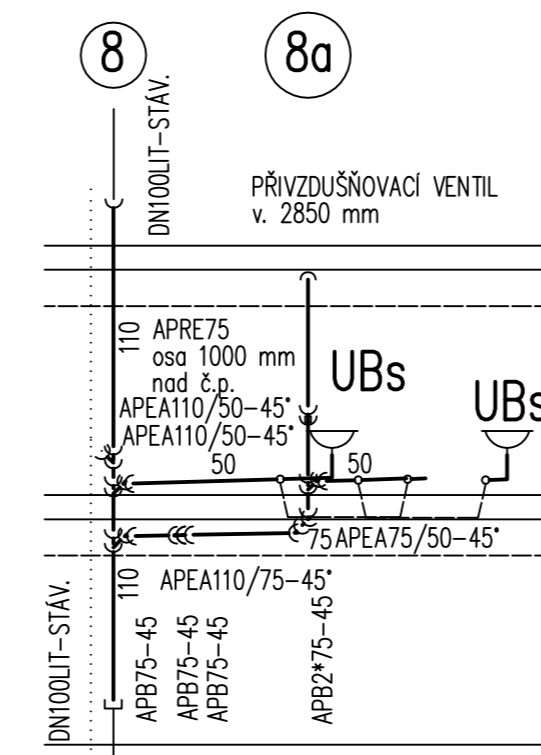

8 8a

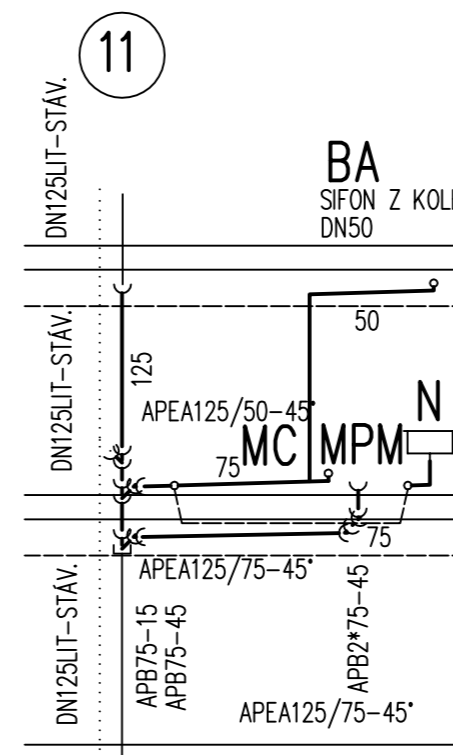

11 11v

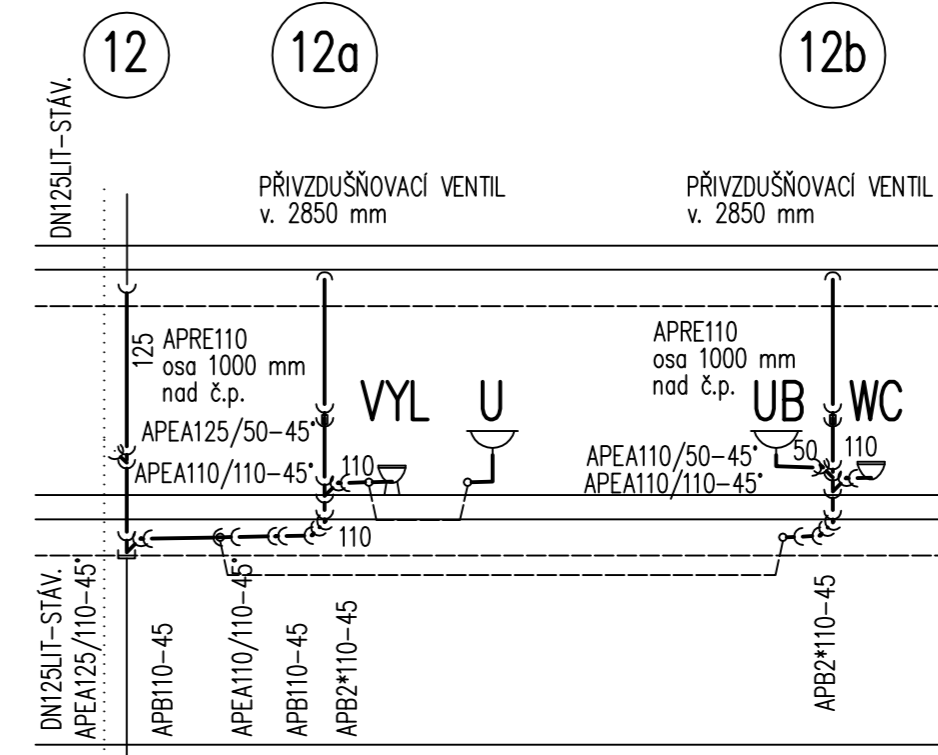

12 12a 12b

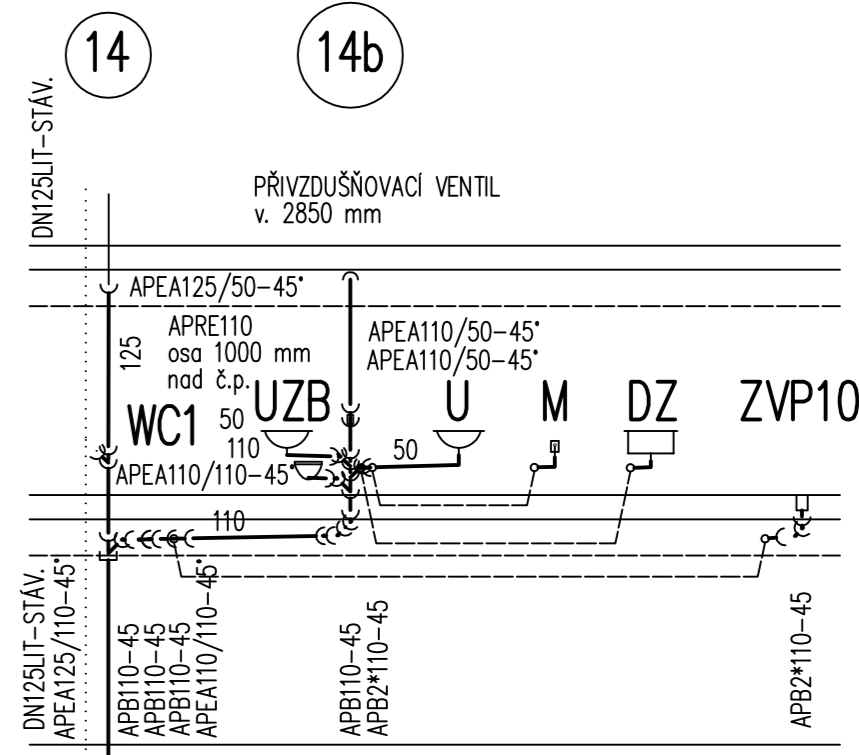

14 14b 14s

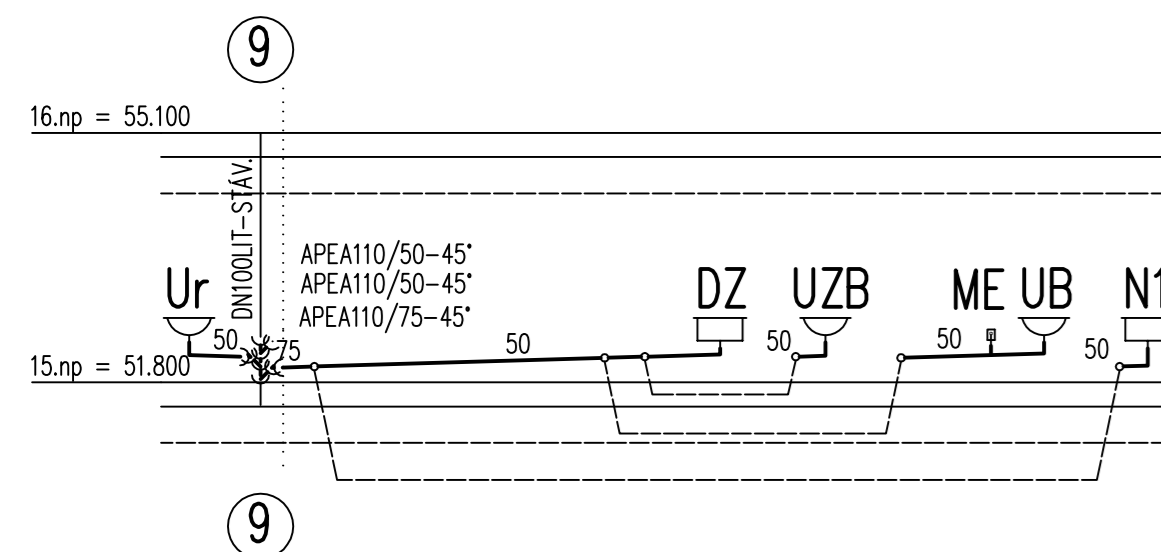

9

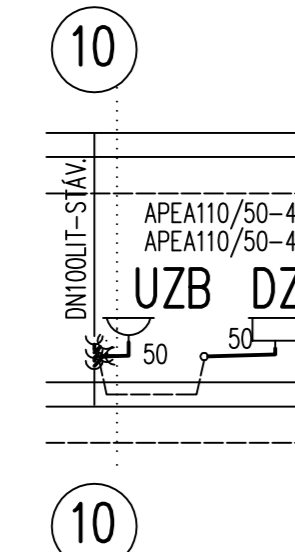

10

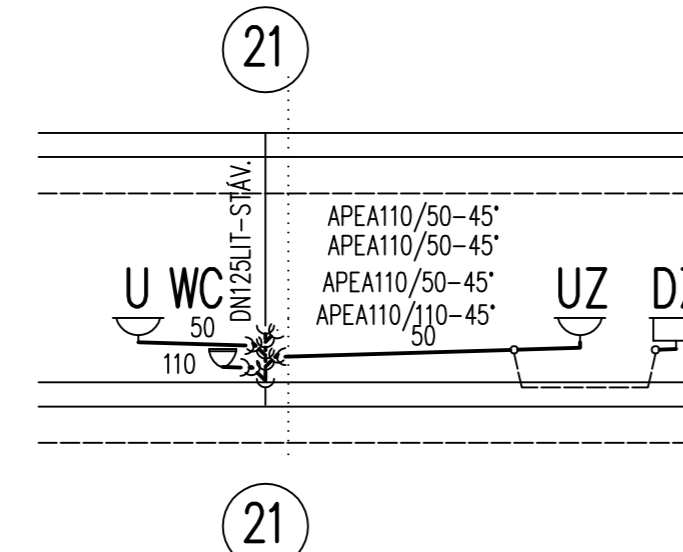

21

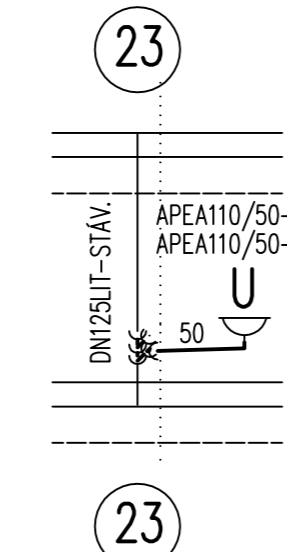

23

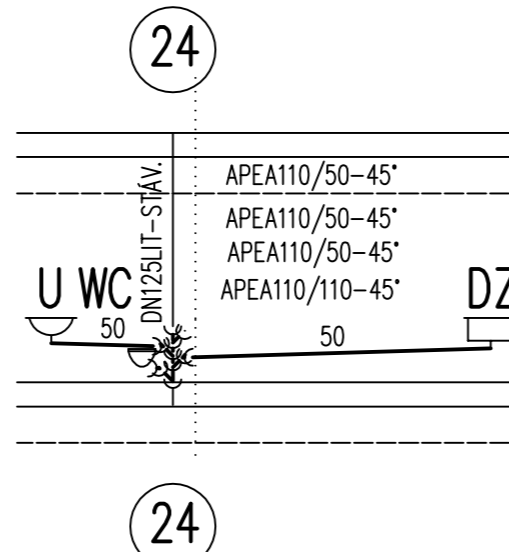

24

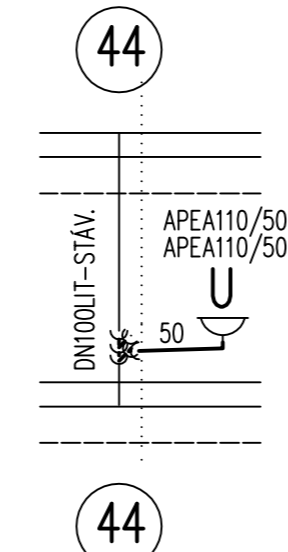

44

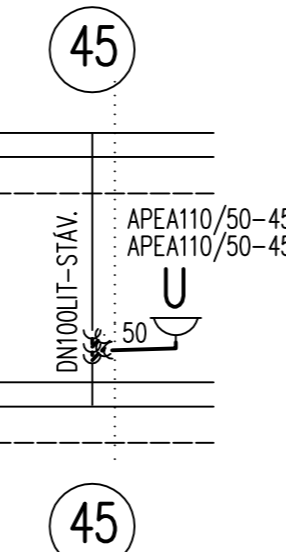

45

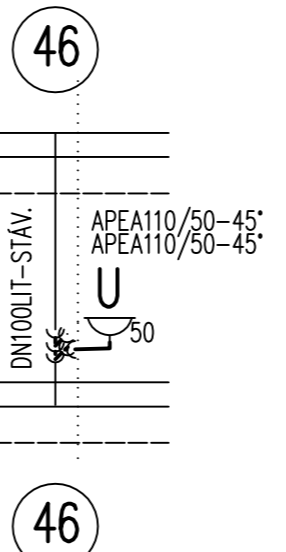

46

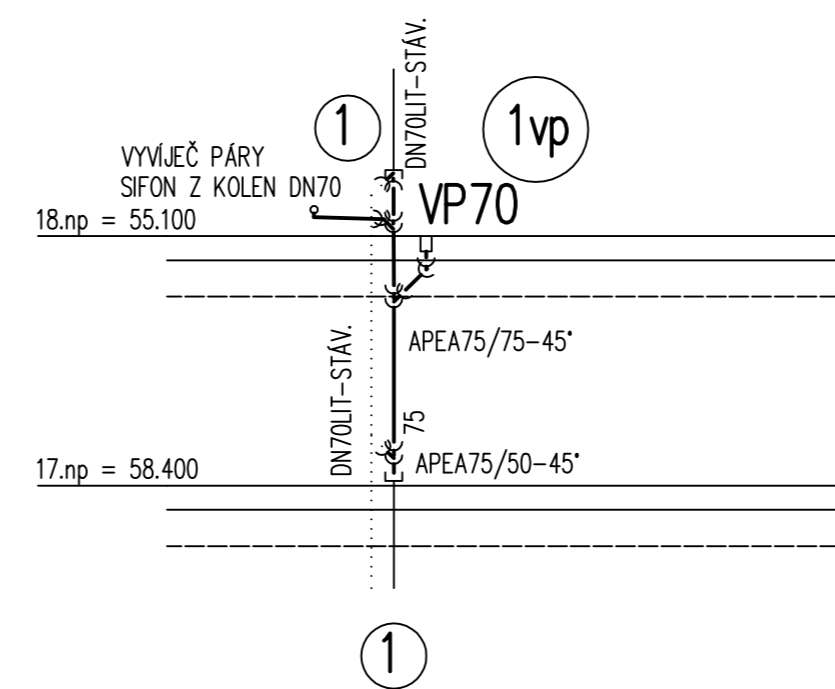

1 1vp

±0,000 = 1.NP BUDOVY L = 280,700 m n.m.

Revize	Vypracoval	Popis obsahu revize	Datum

LT PROJEKT PRŮJEKTOVÁNÍ ZDRAVOTNICKÉ VÝSTAVBY		Hlavní inženýr projektu: Vedoucí projektant zakázky:	
Profese: ZTI		Zpracovatel dílu: HP consult s.r.o., Durdákova 5, Brno 613 00	
Odpovědný projektant:		Vypracoval:	
Akce: FN BRNO REKONSTRUKCE JIP KLINIKY IGEK		Zakázkové číslo: DPS 23 - 2017	
Objekt: BUDOVA L - 15.NP		Datum: 06 - 2017	
Obsah: SCHÉMA KANALIZACE		Formát: 5xA4	
SO 01		Stupeň: DSP + DPS	
Měřítko: 1:100		Číslo výkresu: D1.01.04-107	
Investor: FAKULTNÍ NEMOCNICE BRNO		Fakultní nemocnice Brno Jihlavská 20, 625 00 Brno +420 532 231 111 fnbrno@fnbrno.cz	
Autorizace:		Paré:	