

Ground plan

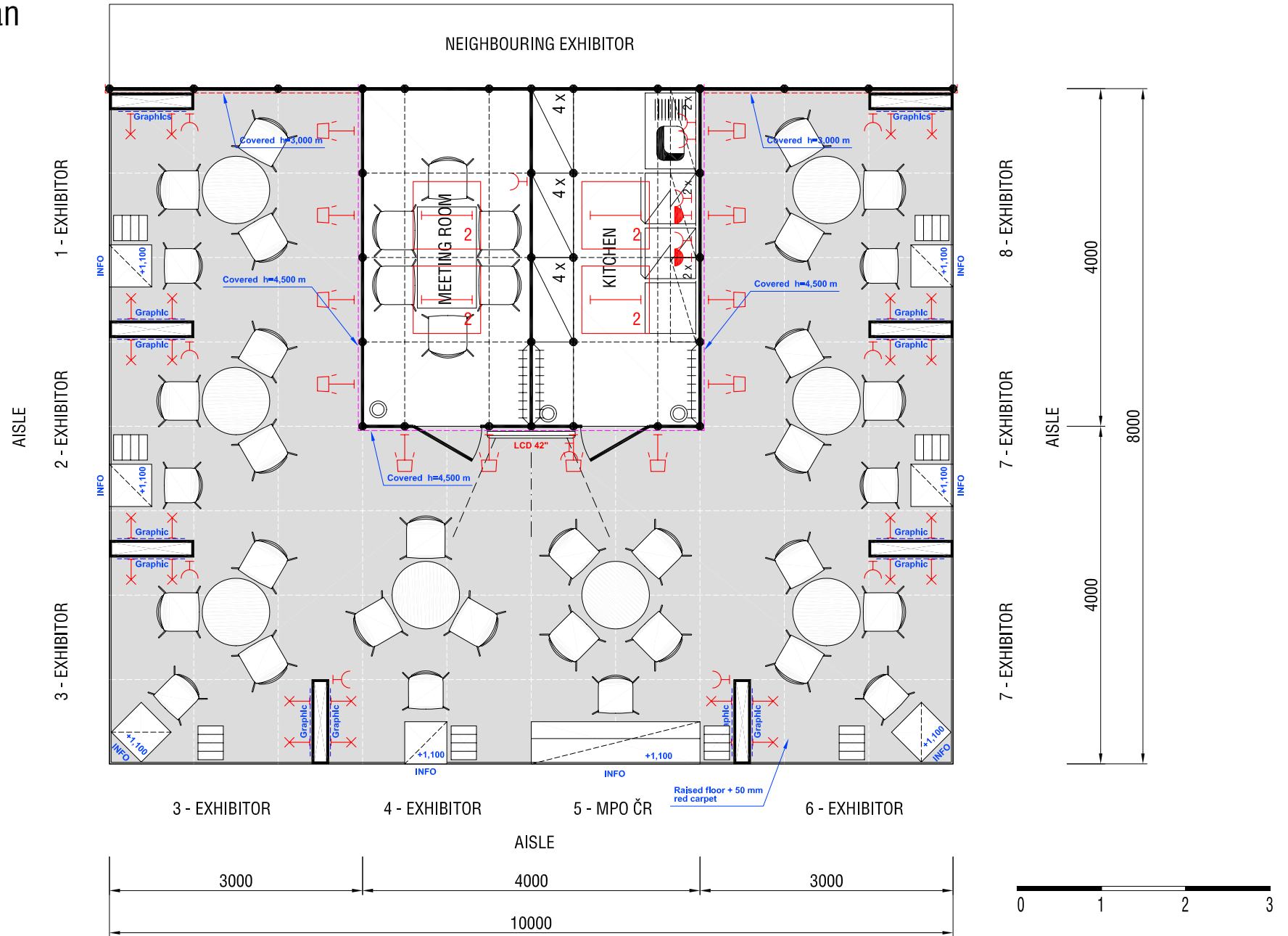













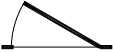

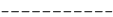
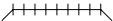

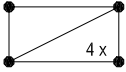





LEGEND:







STRUCTURAL ELEMENTS

	WOODEN WING DOOR
	WHITE WALL (PANEL)
	CEILING GRID
	HAT AND COAT HANGER (OCTANORM)
	PILLAR
	INFORMATION COUNTER 50 / 50 / 110 cm (WHITE) LOCKABLE
	OCTANORM RACK 100 / 50 / 250 cm (FOUR WHITE SHELVES)
	TWO FLAT SHELVES ON THE WALL 100 / 30 cm (OCTANORM / WHITE BOARD)

FURNITURE ELEMENTS

	TABLE ROUND d = 70 cm (WHITE TOP BOARD / CHROM)
	CHAIR (WHITE / CHROM)
	BARHOCKER (WHITE / CHROM)
	STANDING TABLE ROUND 60 / 110 cm (WHITE TOP BOARD / CHROM)
	TABLE 60 / 60 cm (WHITE TOP BOARD / CHROM)
	KITCHEN SINK UNIT WITH CUPBOARD AND HOT - WATER HEATER (POWER AND WATER CONNECTION)
	REFRIGERATOR 170 l (WHITE)
	WASTE CONTAINER
	LITERATURE DISPLAY STAND

ELECTRICAL ELEMENTS

	FLOURESCENT TUBE 2 x 20 W WITH METAL GRID CEILING
	KITCHENETTE UNIT (WITH BOILER)
	SOCKET
	SOCKET 24 HOUR
	SPOT LIGHT 100 W ON THE ARM
	SPOT ON LONG BRACKET - 150 W - "SHOVEL"