

R1

R2

R3

R4

R6

R7

R8

R12

R17

R18

R23

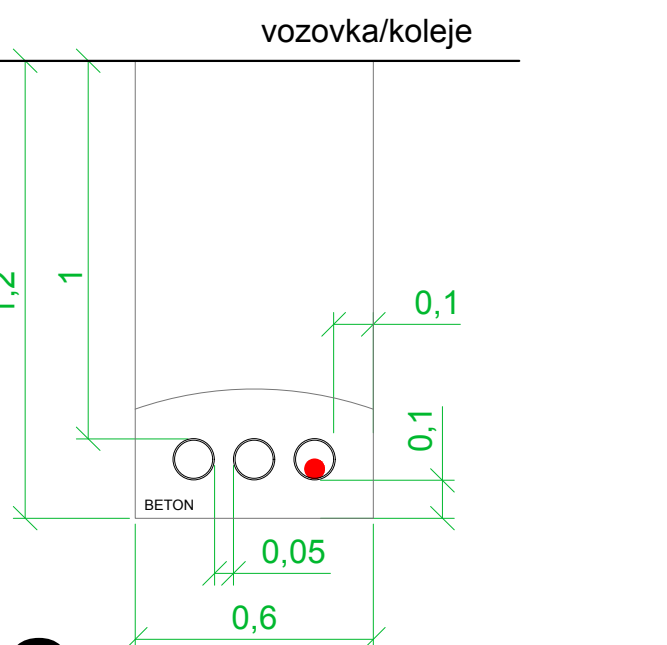
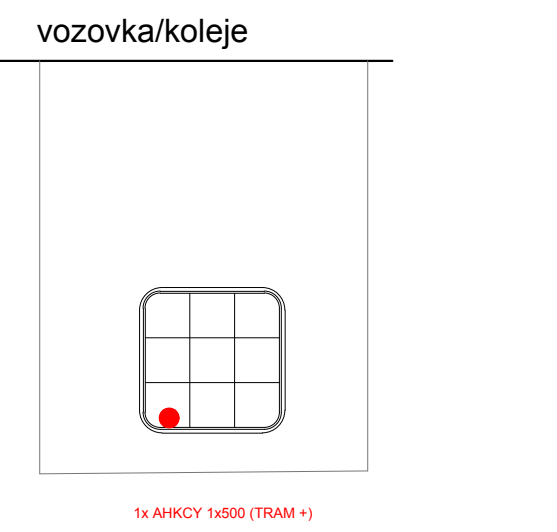
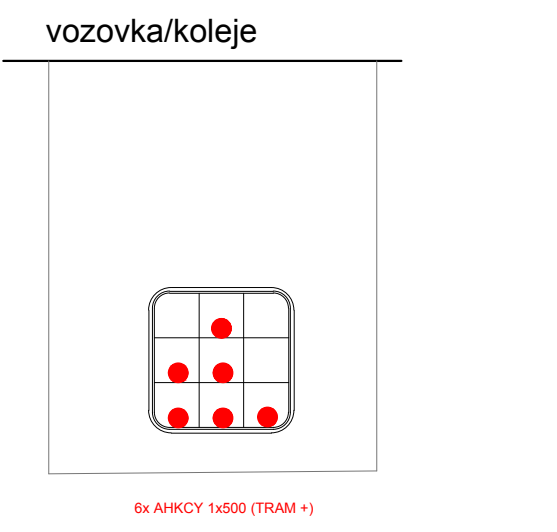
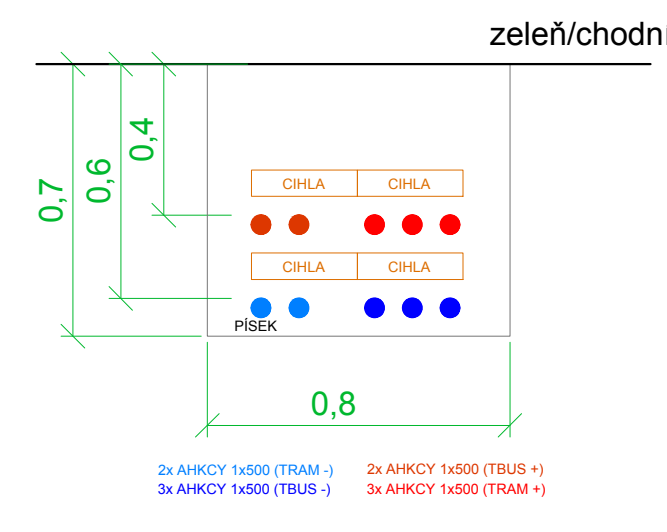
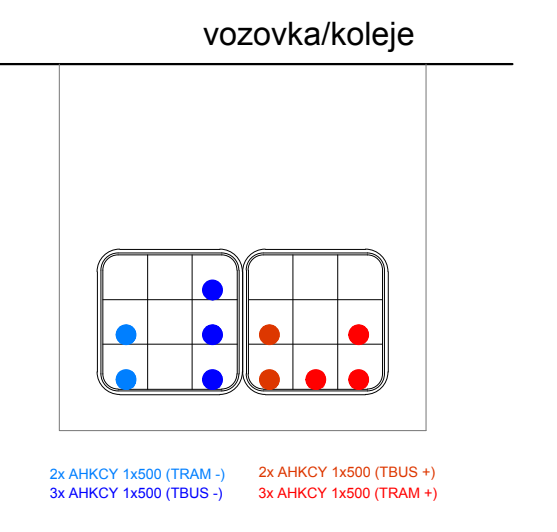
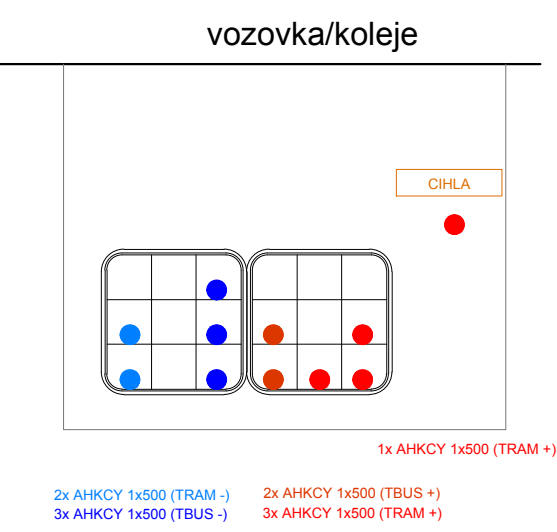
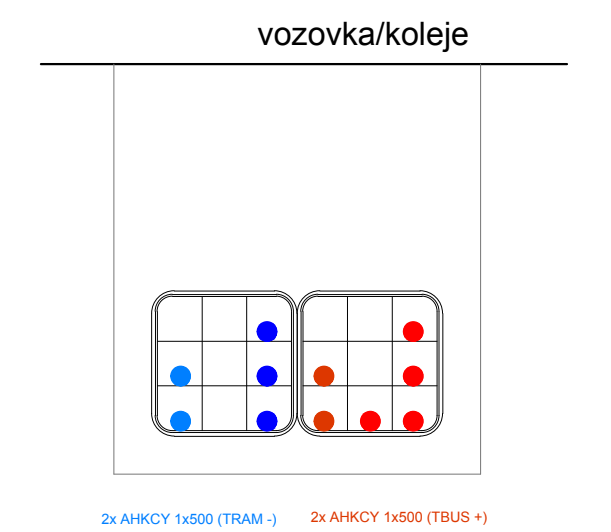
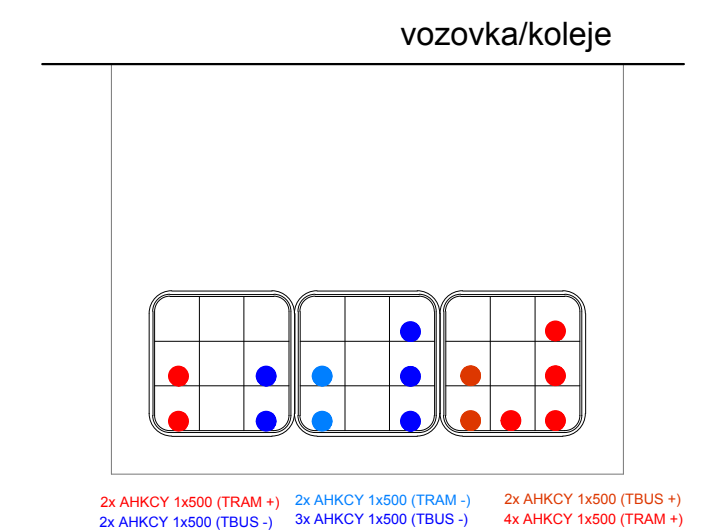
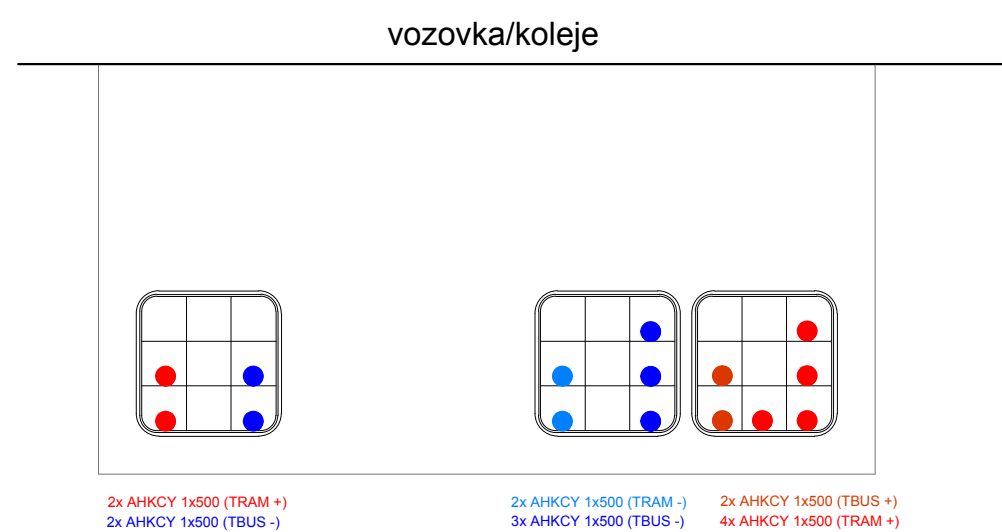
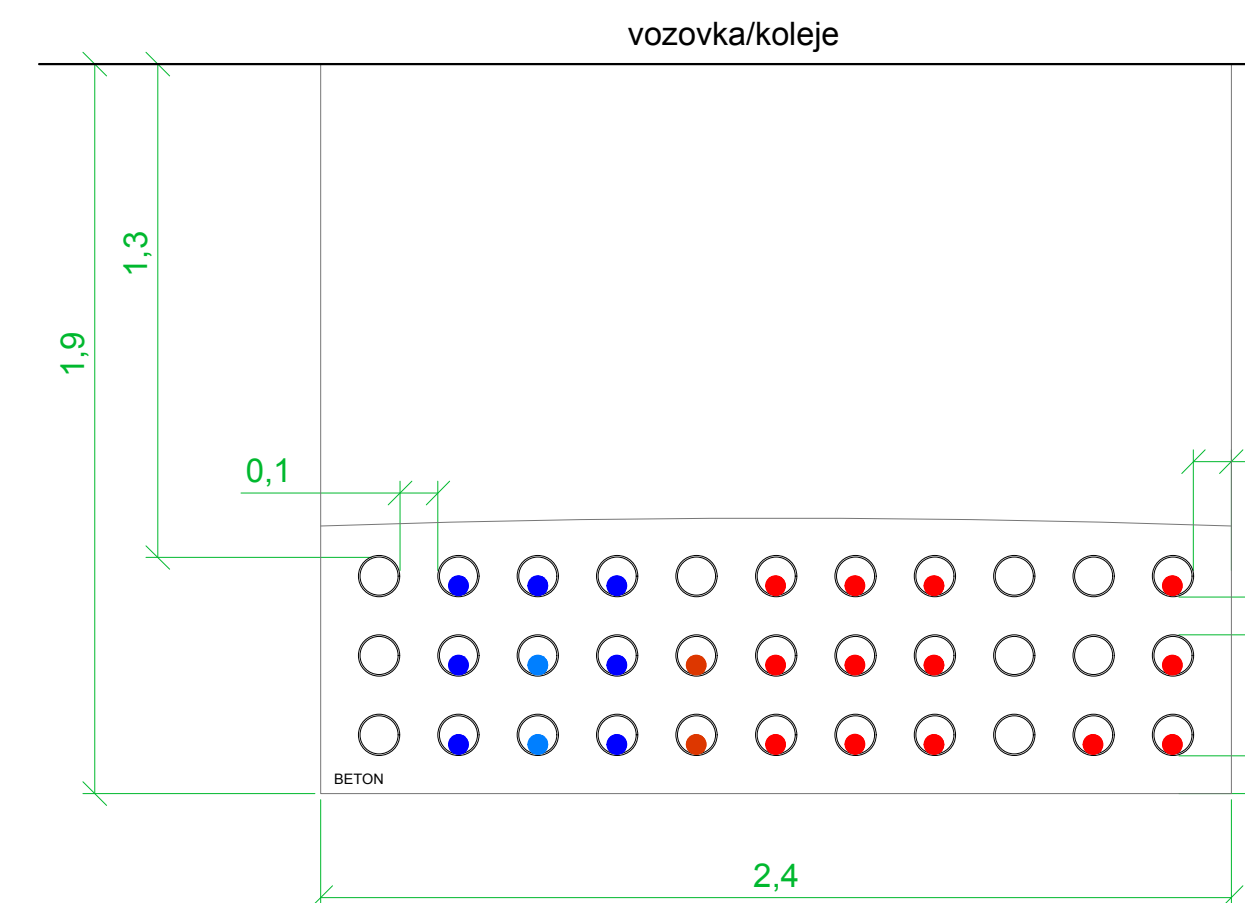

R5

R9

R10

R11

R13

R14

R15

R16

R19

R20

R21

R22

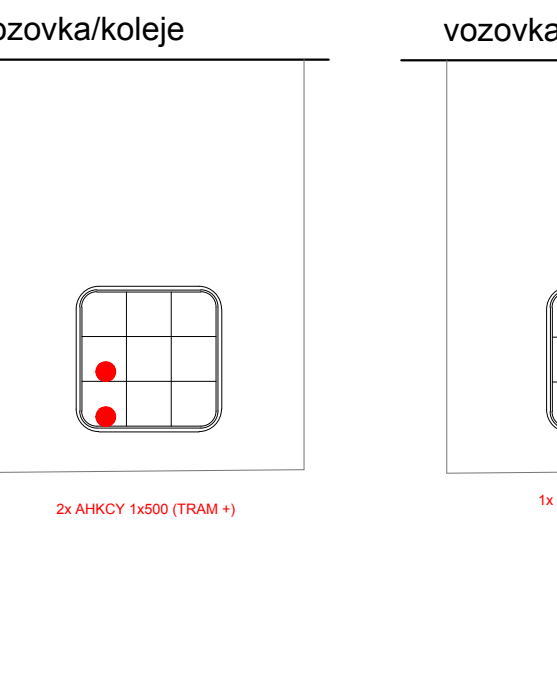
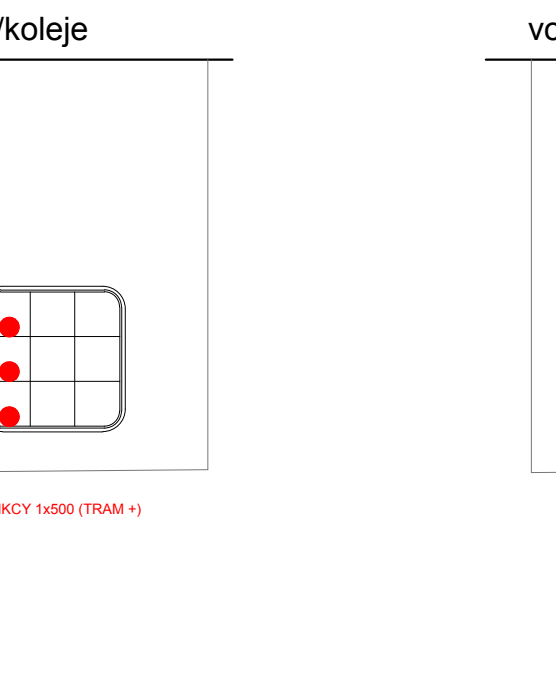
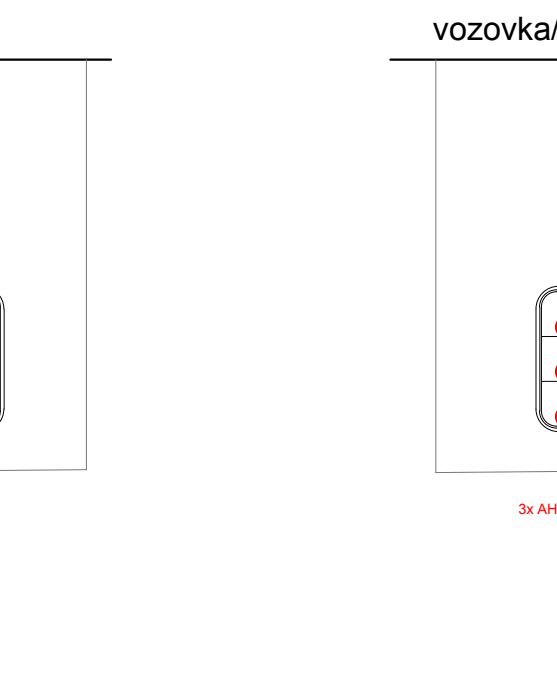
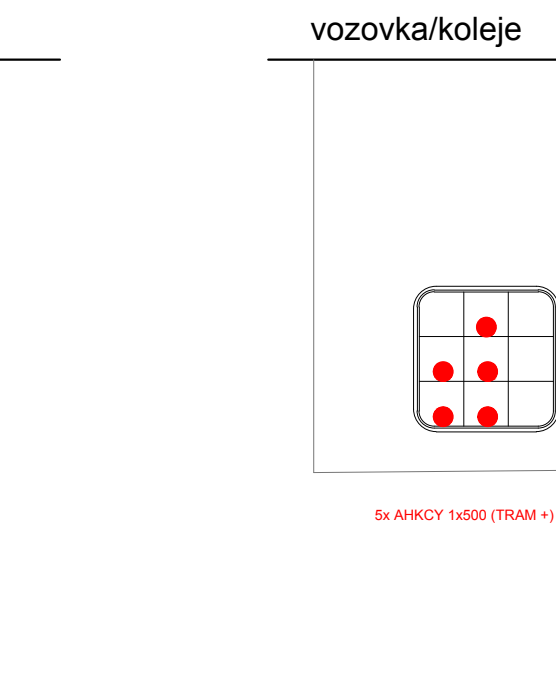
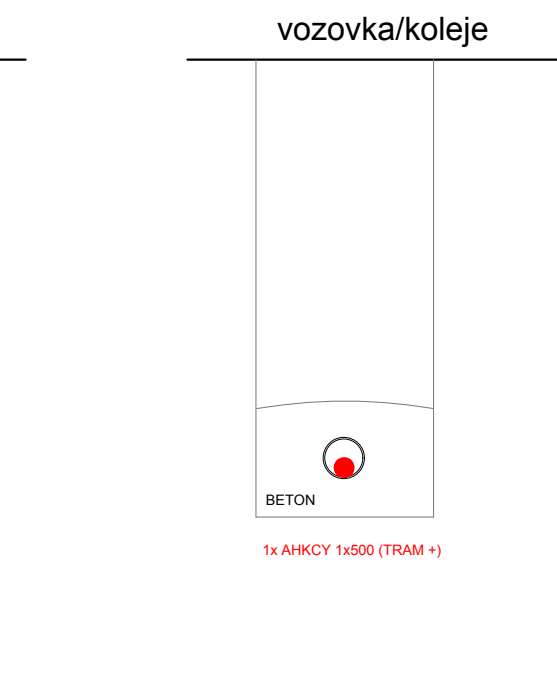
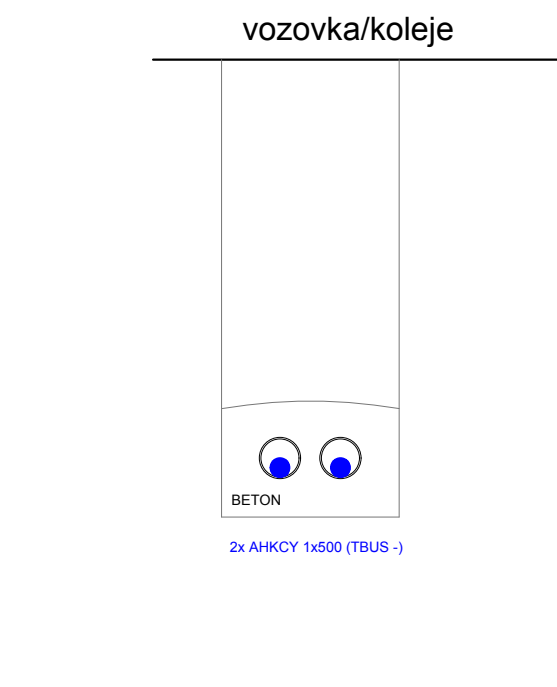
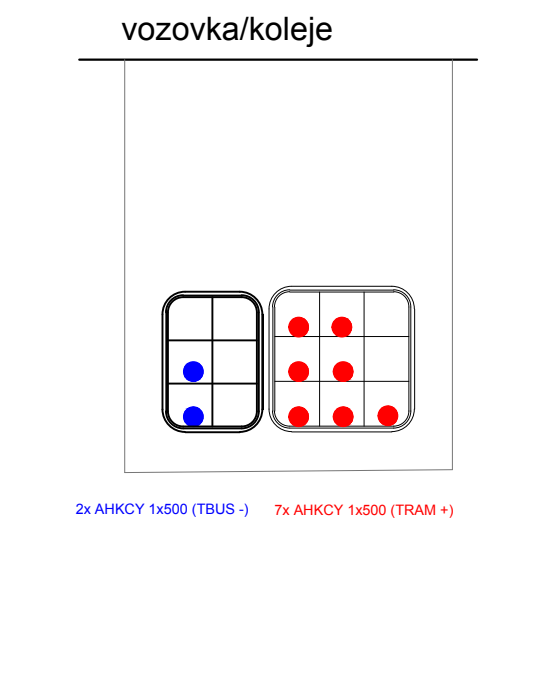
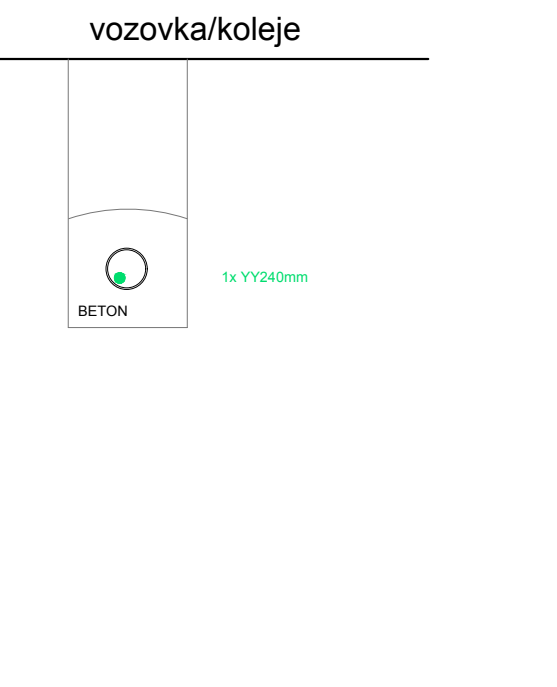
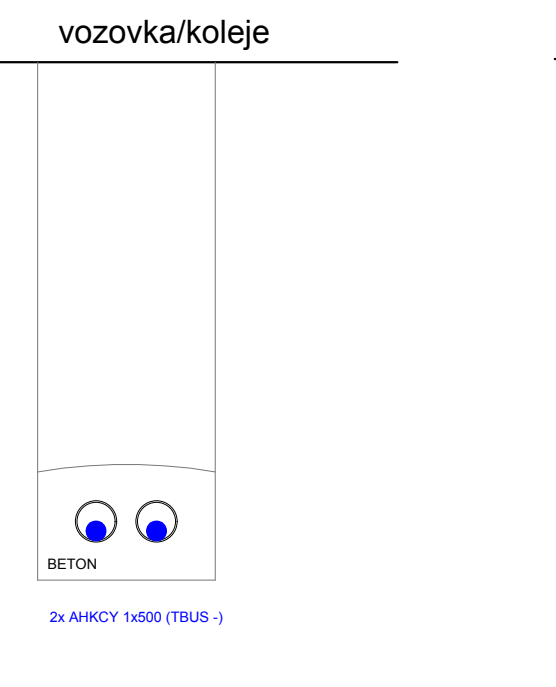
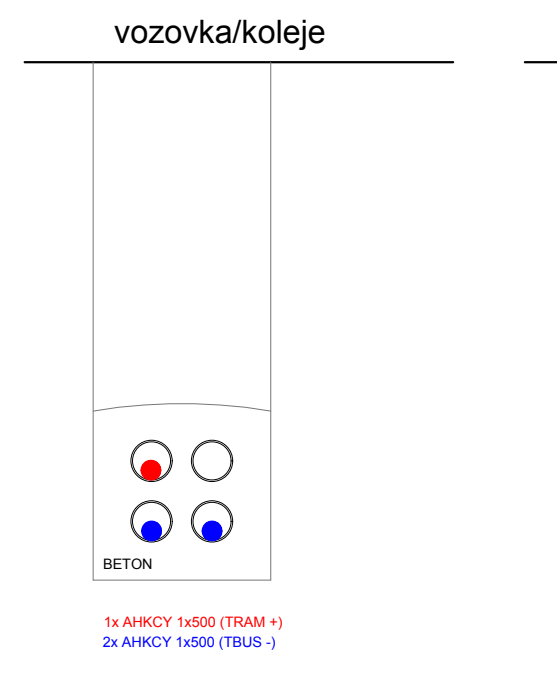
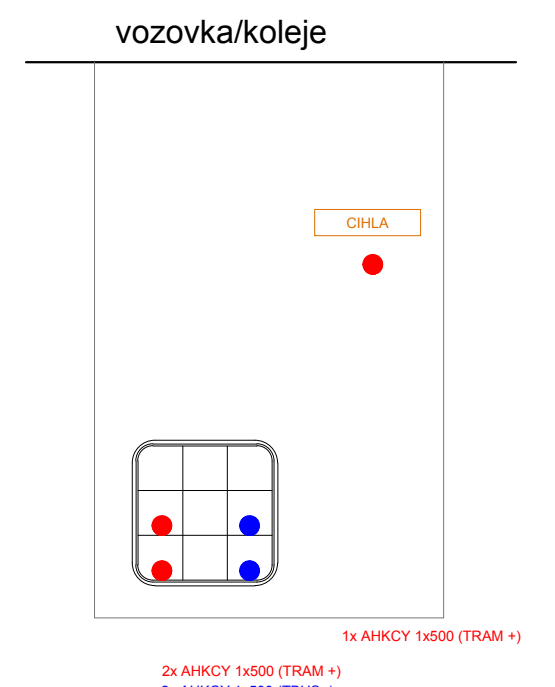
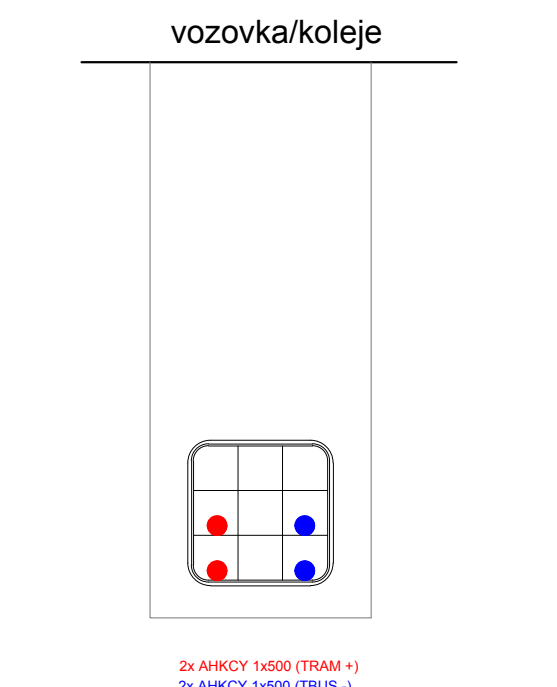

OBJEDNATEL:		Pízeňské městské dopravní podniky, a.s. Denisovo nábřeží 920/12 301 00 Pízeň - Východní Předměstí	
společnost "MP + MMD - Vozovna Slovany", společník 1:		společník 2:	
METROPROJEKT Praha a.s. nám. I. P. Pavlova 2/1786 120 00 Praha 2 tel.: +420 296 154 105 www.metroprojekt.cz		Mott MacDonald CZ, spol. s r.o. Národní 984/15 110 00 Praha 1 tel.: +420 221 412 800 www.mottmac.com	
HIP: Ing. Jan Kočí tel.: 296 154 401 Stupeň: DSP		Podpis: <i>Kočí</i> Název a úhel díla: REKONSTRUKCE VOZOVNY SLOVANY Plzeň, Slovanská alej 35	
Zpracovatelský úvaz: S 80 tel.: +420 296 154 400 Vedoucí úvaz: Ing. Jakub Huml		Název části díla: E. Stavební část - stavební soubory SOD II Objektu odstavní tramvají (ODT) E.5 Elektro a sdělovací objekty SO ODT 20/3 Kabelové vedení	
Odpovědný projektant: Ing. Kateřina Švehlová Vypracoval: Ing. Miroslav Hudec		Podpis: <i>Švehlová</i> Podpis: <i>Hudec</i> Název přílohy: Typové kabelové řezy	
Skart. znak: V20/2039 Počet formátů: 7xA4		Datum: 11/2019 Měřítko: 1:50 IČD: 19 7246 006 06 07 01c	
		Změna: - Číslo příl.: 004	