

KSV NIMA

KSV NIMA Surface Potential Sensor

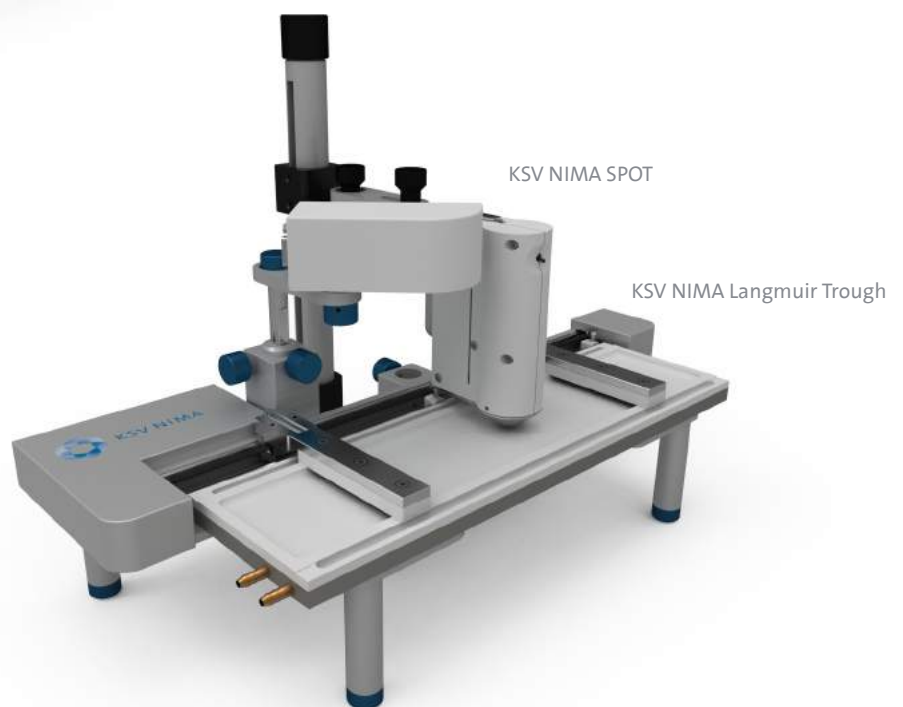

KSV NIMA Surface Potential Sensor

The KSV NIMA Surface Potential Sensor is a compact and highly sensitive characterisation instrument that offers complementary data on the packing and orientation of Langmuir films. The KSV NIMA Surface Potential Sensor (SPOT) measures the potential difference above and below the film.

Applications

The KSV NIMA Surface Potential Sensor allows complementing data from surface pressure - area isotherm measurements that are obtained from a Langmuir and Langmuir-Blodgett Trough. It allows the determination of monolayer composition, molecular orientation, degree of molecular dissociation and molecular interactions at the interface. The most common applications are:

- **Determining effective dipole moments**

The KSV NIMA SPOT can be used to determine effective dipole moments through simple surface potential measurements of a compressed film.

- **Determining molecular orientation**

The KSV NIMA SPOT can be used to obtain information on molecular orientation by observing changes in surface potential and combining the data with surface pressure information.

- **Film electronic structure characterisation**

Even the smallest change in the electronic structure of molecules can be detected by measuring the change in surface potential.

- **Molecular structure characterisation**

Quantify the effects of changes to molecular structure through positional offsets and peak values of the surface potential plots.

- **Complex formation monitoring**

Observe and follow complex formations between monolayers, subphase species or adsorbates.

Working principle

The KSV NIMA Surface Potential Sensor measures the potential difference above and below the film and is sensitive to the sum of all the individual dipole moments. The changes in surface potential are measured by detecting the potential difference between the vibrating plate which is placed above the monolayer and the counter electrode which is immersed in the subphase below the monolayer.

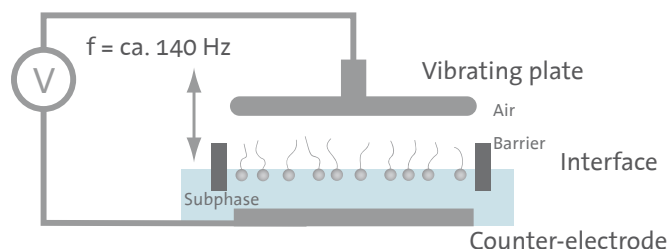

$$\Delta V = \mu_n / \epsilon \cdot \epsilon_0 \cdot A$$

with

ϵ = subphase permittivity (e.g. here water)

ϵ_0 = air permittivity

A = area per molecule

μ_n = vertical component of the dipole moment

GRAPH 1

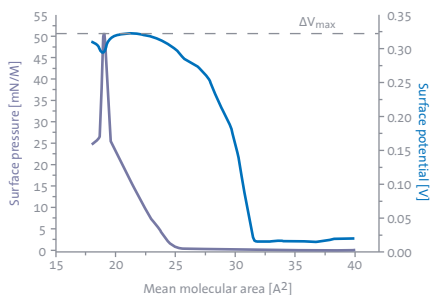

GRAPH 2

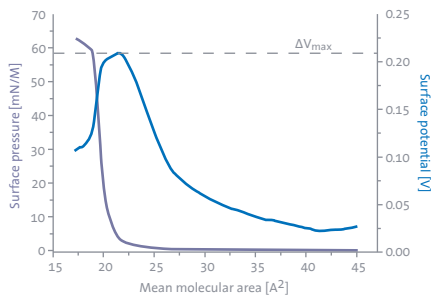

GRAPH 3

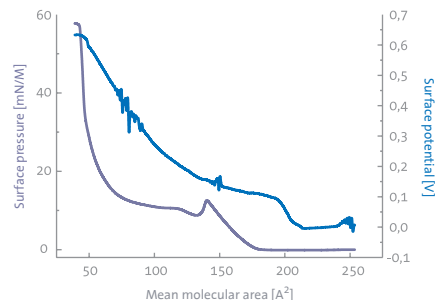

Technical specifications

Measurement:

Input range: -5V to +5V
 Sensitivity: +/- 1mV
 Drift: +/- 5mV/h
 Height dependency: 10mV/mm
 Response time: Proportional to distance but less than 1s when positioned 1mm above monolayer
 Calibration: Factory calibrated

Hardware:

Measuring head dimensions: 100x85x20mm
 Probe diameter: 16mm
 Stand base height: 19mm
 Maximum sensor height: 160mm
 Counter-electrode plate dimensions: 35x50x2mm
 Vertical electrode arm length: 20mm

Software:

Fully incorporated into KSV NIMA LB Software for Langmuir and Langmuir-Blodgett Troughs.

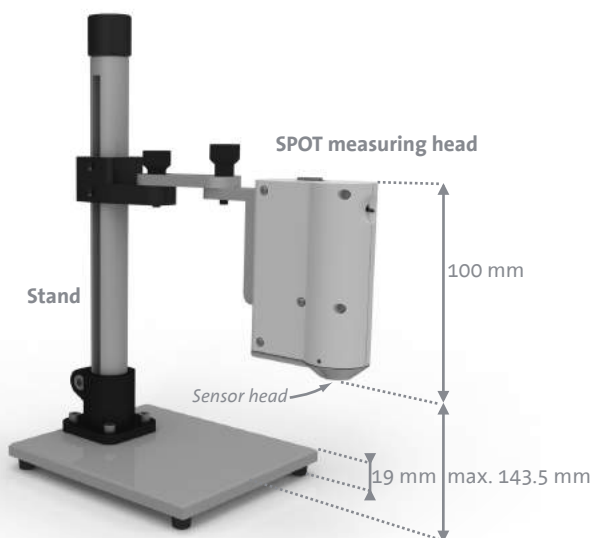

Measurement examples

Graph 1 & 2

Using a KSV NIMA Langmuir Trough, a monolayer of Stearic acid was spread onto a subphase and the surface potential was measured with the KSV NIMA SPOT. The first experiment (Graph 1) used a subphase of deionised water (pH=5.6). In the second experiment (Graph 2) a solution of Cadmium Chloride ([c]=0.1 mM, pH=6.7) was used as a subphase. The surface pressure - area isotherm and the surface potential (ΔV) data were recorded using the KSV NIMA LB Software which automatically records both plots simultaneously.

In the case of Graph 1 (deionised water), ΔV_{max} was found to be 322 mV. Upon changing the subphase from water to cadmium chloride (Graph 2), the measured ΔV_{max} was reduced to 209 mV. This lower ΔV_{max} value can be explained by the interaction of Cd^{2+} ions with the dissociated carboxylic acid head groups of the Stearic acid monolayer, contributing to a decrease in surface potential. These results are in very good agreement with literature.

Graph 3

The KSV NIMA LB Software graph displays both the surface pressure-area and the surface potential-area isotherms of an antiparasitic drug monolayer on an air-buffer solution interface. An unusual surface pressure-area transition was observed at mean molecular area of 140 \AA^2 , but no transition was shown in the surface potential-area isotherm. This suggests that the transition is not a phase transition but instead the drug could undergo aggregation, dimerization or conformational change at this mean molecular area.

SPOT counter electrode

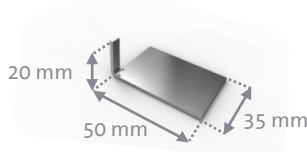

The counter electrode is placed in the subphase with the arm protruding through the subphase surface. This plate is connected to the SPOT measuring head by a cable.

Product benefits

- Accurate and reproducible measurements
 - *The non-contact and non-destructive vibrating plate capacitor method ensures very good accuracy and reproducibility.*
- Software integrated to the KSV NIMA L and LB Trough Software
 - *The KSV NIMA Surface Potential Sensor does not require any additional software and can be easily installed by a simple plug and play operation. The latest version of KSV NIMA LB Software, supplied with all KSV NIMA Langmuir and Langmuir-Blodgett Deposition Troughs, displays the recordings of the surface pressure and surface potential on the same plot. Colour coded axes and plots ensure that the two recordings are clearly presented.*
- Easy set up
 - *The KSV NIMA Surface Potential Sensor connects directly to your existing KSV NIMA Interface Unit, supplied with all KSV NIMA Langmuir and LB Deposition Troughs. The KSV NIMA SPOT is provided with a flexible stand allowing rapid and easy integration to your trough. Furthermore, the instrument is factory calibrated for a quick start up.*

Compatibility

It is recommended to use the KSV NIMA Surface Potential Sensor together with a KSV NIMA Langmuir, Langmuir-Blodgett or Microscopy Trough to be able to combine surface pressure and surface potential measurements. The KSV NIMA Surface Potential Sensor can also be used with other Troughs along with a KSV NIMA Interface Unit.

Specifications and appearance are subject to change without prior notice. Biolin Scientific shall not be liable for any errors in this document.



KSV NIMA

KSV NIMA – at the creative interface of people and technology

We create value for our customers by providing advanced, innovative instruments for thin film fabrication and characterisation, by constantly exchanging knowledge with our customers and through building open, trusting relationships with customers and partners.

Availability

KSV NIMA products and services are provided to customers all over the world through Biolin Scientific in co-operation with a highly competent network of Distribution Partners. For a list of relevant contact details, visit www.ksvnima.com

Contact information

KSV NIMA
Biolin Scientific
Tietäjantie 2
FIN-02130 Espoo, Finland

Tel +358 9 5497 3300
Fax +358 9 5497 3333

info@ksvnima.com
www.ksvnima.com