

## MINIPŘELÍZKA 18

Věková skupina:  
3 - 12 let

Počet uživatelů



Rozměr konstrukce:  
d= 3,50 m  
š= 0,85 m  
h= 1,00 m



Výška pádu: 30 cm



ČSN EN 1176-1 : 2008



Tráva nebo udusaná  
hlína - 24m<sup>2</sup>

- materiál: dřevo akát / dub  
- spojovací materiál pozinkovaná ocel

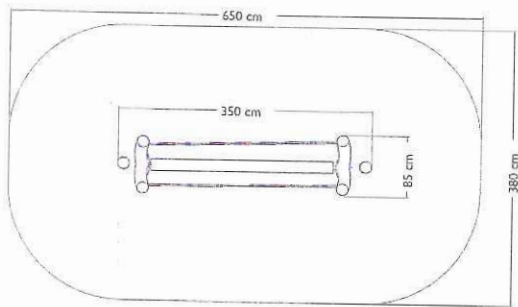

## HOUPAČKA HNÍZDEČKO

Věková skupina:  
4 - 15 let

Počet uživatelů



Rozměr konstrukce:  
d= 1,20 m  
š= 4,40 m  
h= 1,35 m



Výška pádu: 95 cm



ČSN EN 1176-2 : 2008



Tráva nebo udusaná  
hlína - 27m<sup>2</sup>

- materiál: dřevo akát / dub  
- spojovací materiál pozinkovaná ocel  
- PP lana 16 mm s ocelovým jádrem

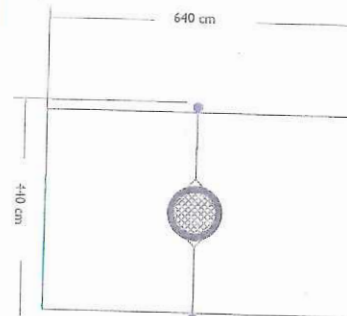
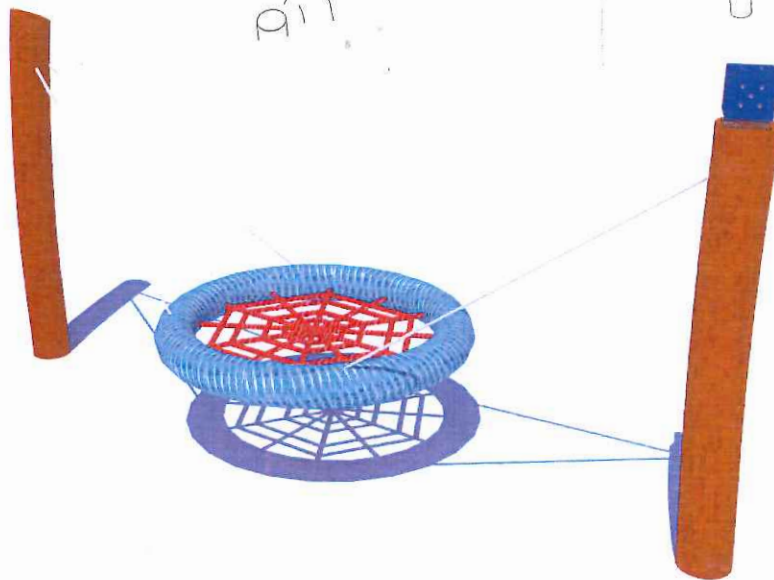
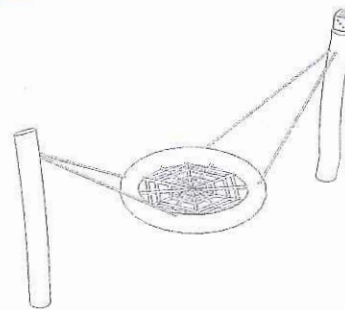
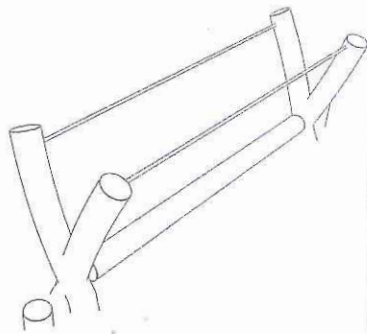
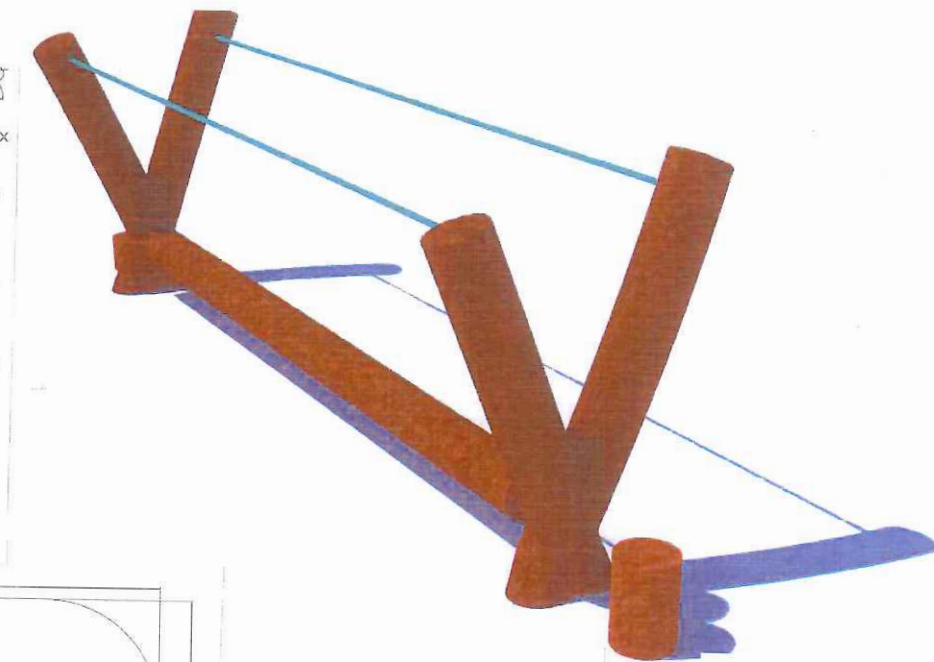

## LEHÁTKO

Věková skupina:  
bez omezení

Počet uživatelů



Rozměr konstrukce:  
d= 2,00 m  
š= 0,60 m  
h= 0,90 m



Výška pádu: 0 cm



ČSN EN 2008



Volný prostor bez  
tlumícího materiálu - 15m<sup>2</sup>

- materiál: dřevo akát / dub  
- spojovací materiál pozinkovaná ocel

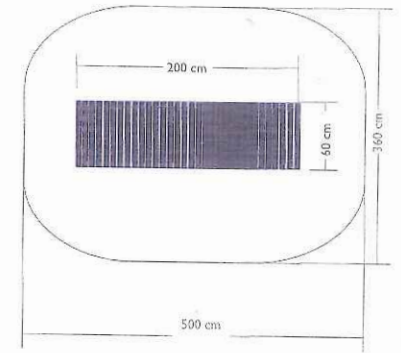

## VIČKA ODRUČKAMI

Věková skupina:  
bez omezení

Počet uživatelů

Rozměr konstrukce:  
d = 1,95 m  
š = 0,65 m  
h = 1,00 m

Výška pádu: 0 cm

ČSN EN 2008

Volný prostor bez  
tlumičeho materiálu - 18m<sup>2</sup>

- materiál: dřevo akát / dub  
- spojovací materiál pozinkovaná ocel

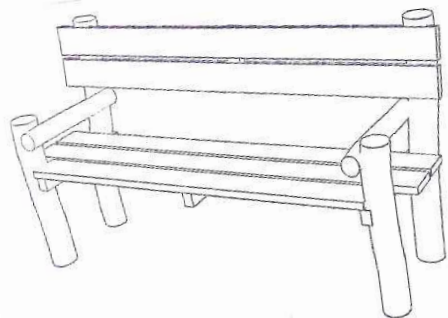
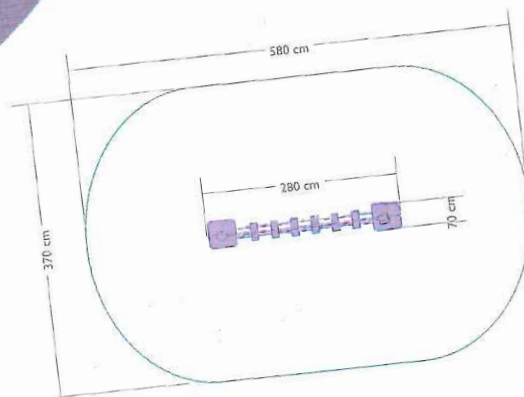
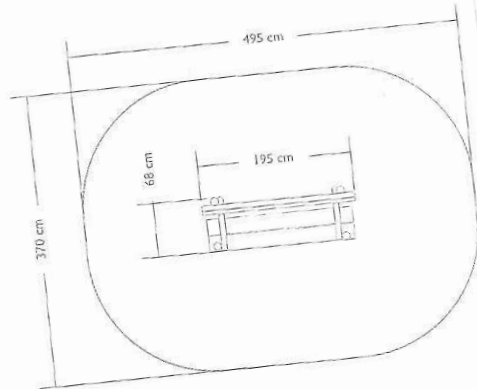
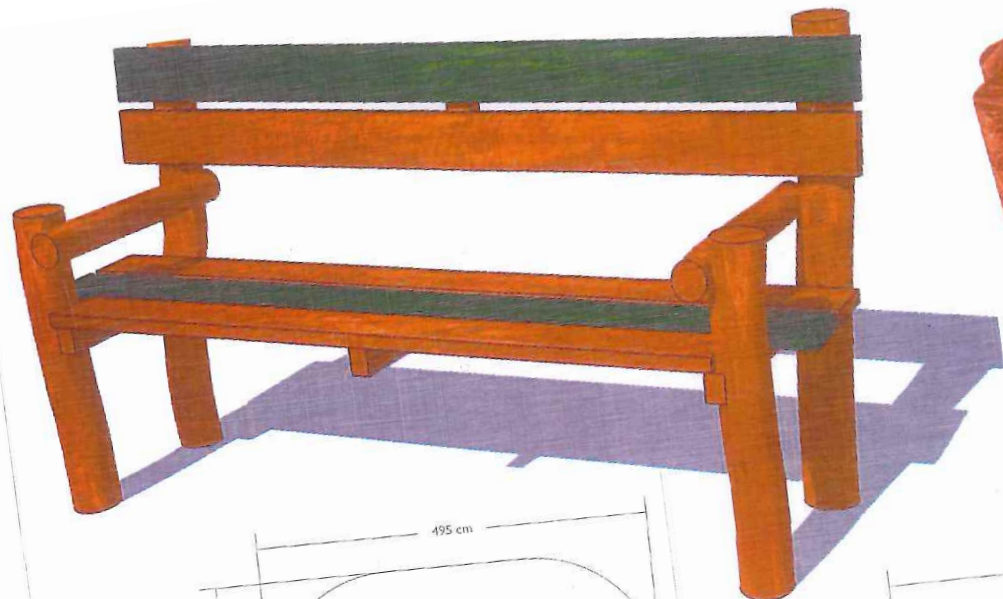

## MINIPŘELÍZKA 3

Věková skupina:  
3 - 12 let

Počet uživatelů

Rozměr konstrukce:  
d = 2,80 m  
š = 0,70 m  
h = 1,60 m

Výška pádu: 60 cm

ČSN EN 1176-1 : 2008

Tráva nebo udusaná  
hlína - 20m<sup>2</sup>

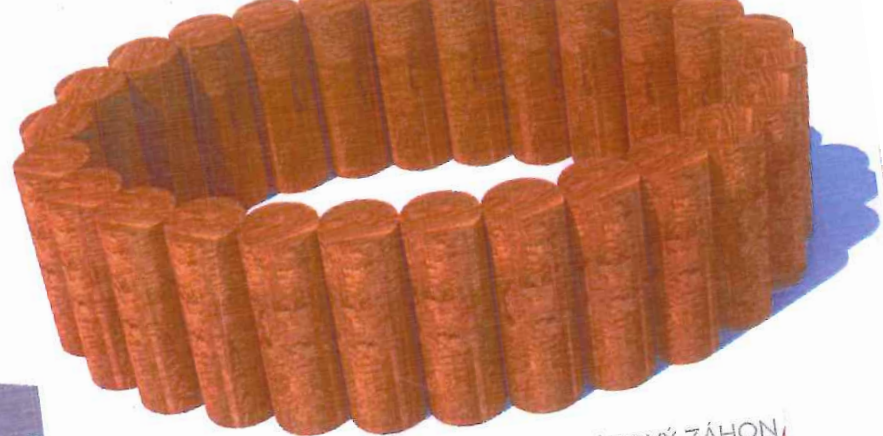
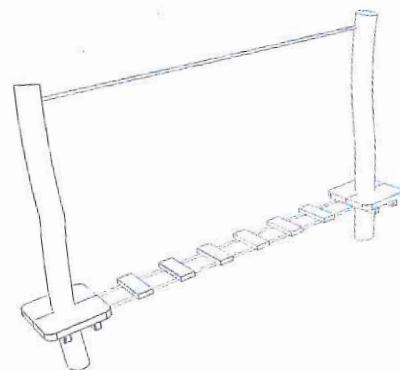
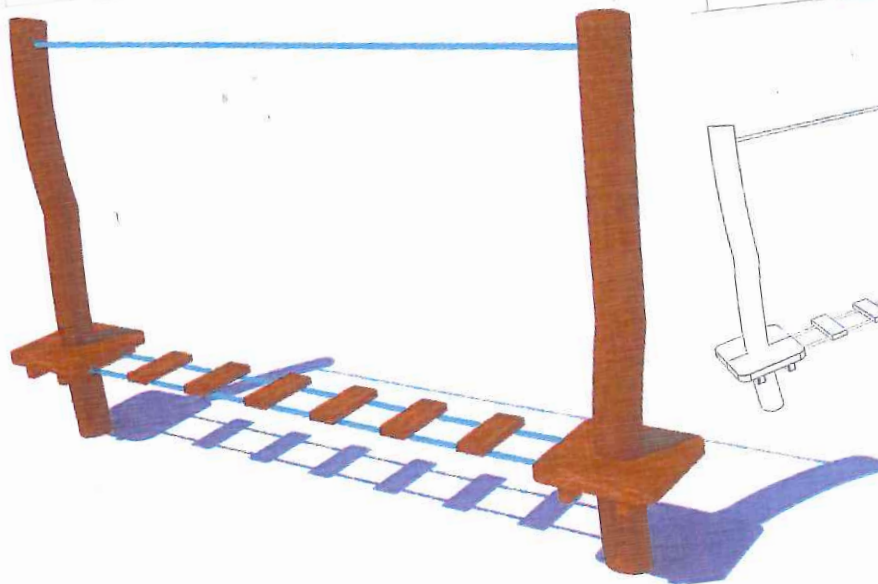

## PALISÁDOVÝ ZÁHON

Věková skupina:  
bez omezení

Počet uživatelů

Rozměr konstrukce:  
d = 1,50 m  
š = 1,50 m  
h = 0,40 m

Výška pádu: 0 cm

ČSN EN 2008

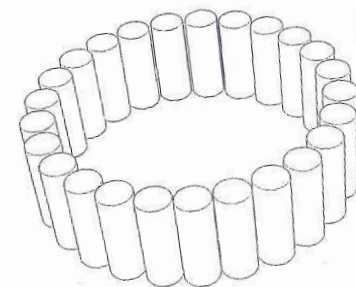
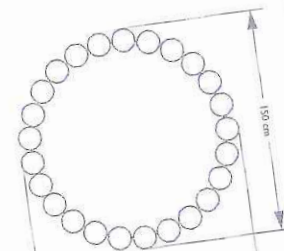



# SMYSLOVÝ CHODNÍK

Věková skupina: bez omezení

Počet uživatelů

Rozměr konstrukce:

d= 6,55 m  
š= 5,60 m  
h= 0,80 m

Výška pádu: 0 cm

ČSN EN 1176-1 : 2008

Volný prostor bez tlumícího materiálu - 58m<sup>2</sup>

- materiál: dřevo akát / dub  
- spojovací materiál pozinkovaná ocel

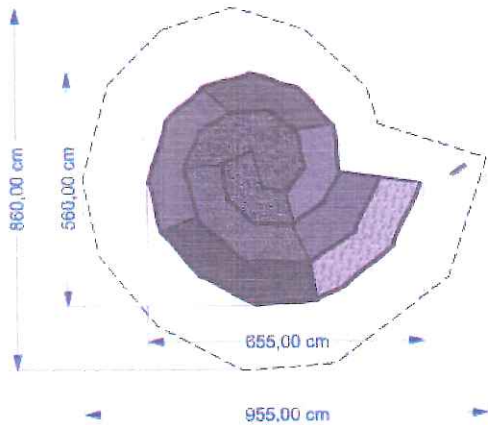
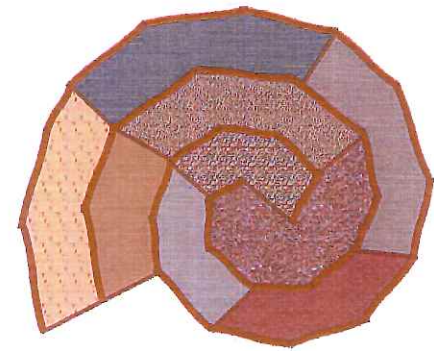

# KMEN NA SEZENÍ

Věková skupina: bez omezení

Rozměr konstrukce:

d= 250 cm  
š= 40 cm  
h= 40 cm

Výška pádu: 0 cm

ČSN EN 2008

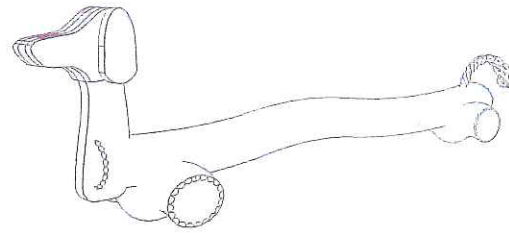

250 cm



40 cm

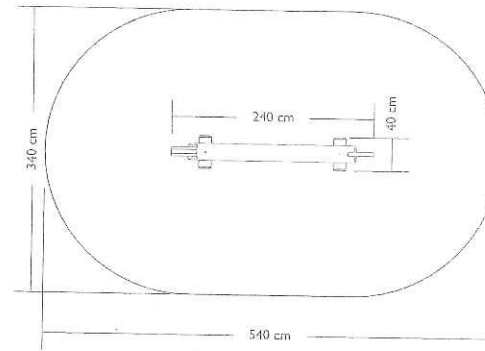
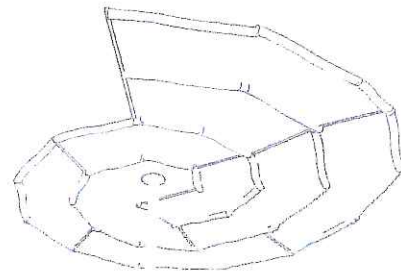
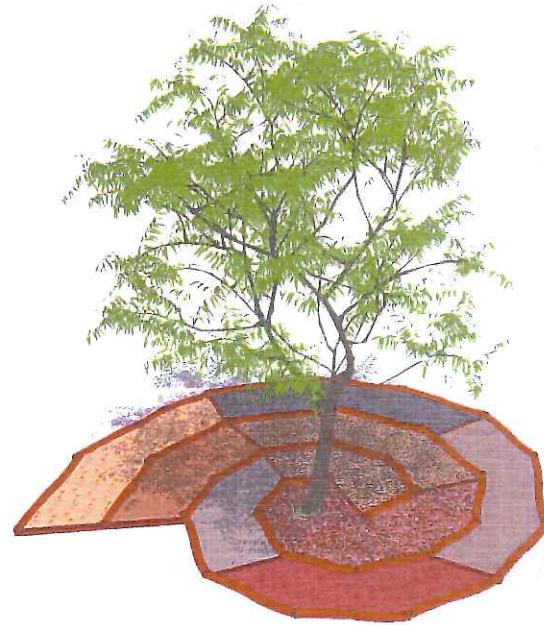

- materiál: dřevo akát / dub  
- spojovací materiál pozinkovaná ocel

# KLADINA ŠPAGETKA

Věková skupina: 3 - 10 let

Počet uživatelů

Rozměr konstrukce:

d= 2,40 m  
š= 0,40 m  
h= 0,60 m

Výška pádu: 60 cm

ČSN EN 1176-1 : 2008

Volný prostor bez tlumícího materiálu - 16,5m<sup>2</sup>

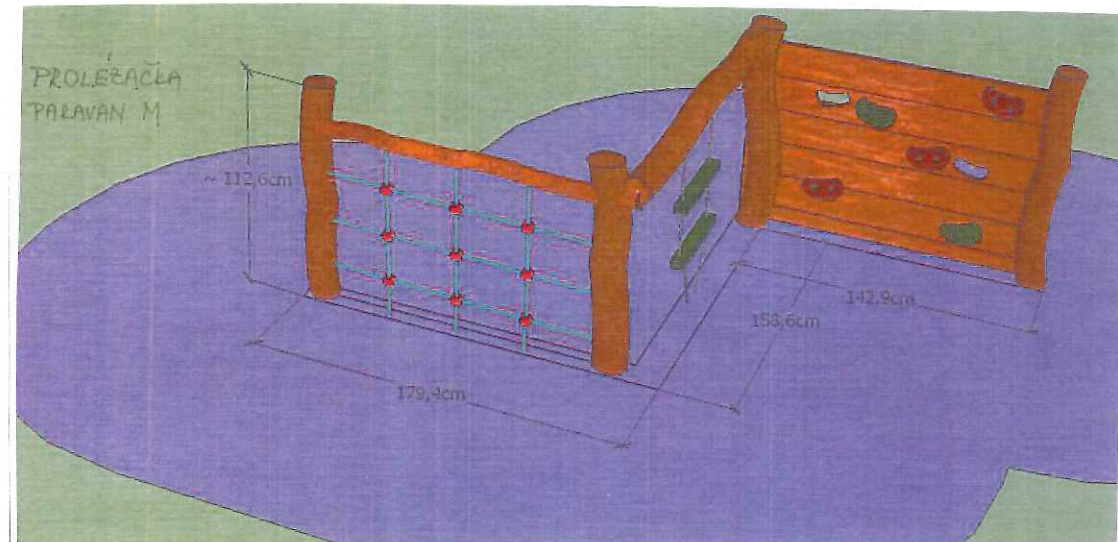
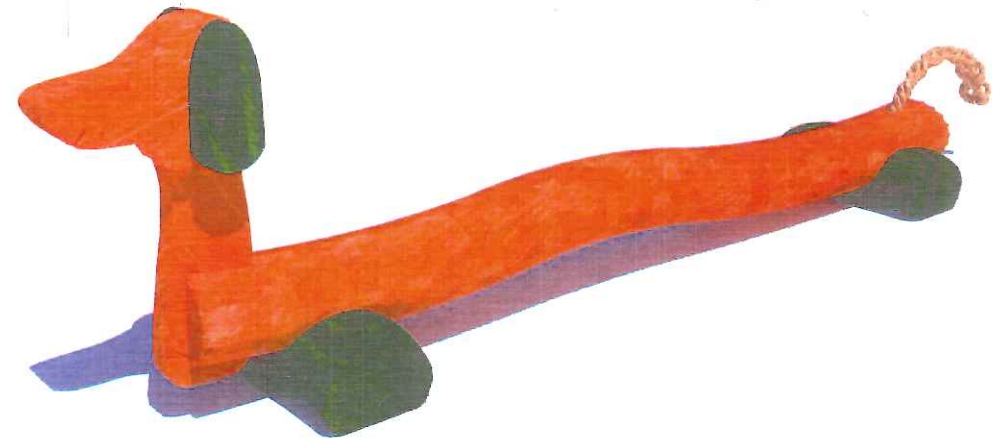

## ZVUKOVOD

Věková skupina:  
bez omezení



Počet uživatelů



Rozměr konstrukce:  
d= 3,50 m  
š= 0,22 m  
h= 1,30 m



Výška pádu: 0 cm



ČSN EN 1176-1 : 2008



Volný prostor bez  
tlumícího materiálu - 20m<sup>2</sup>



- materiál: dřevo akát / dub  
- spojovací materiál pozinkovaná ocel

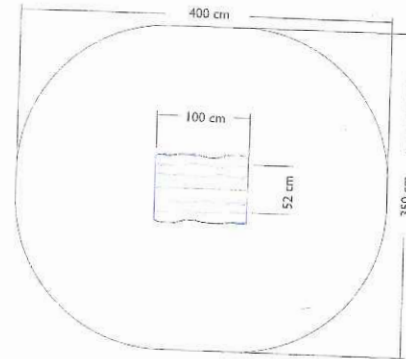
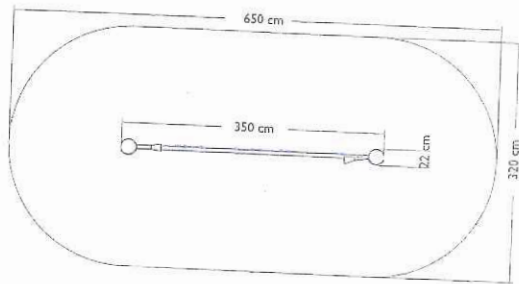
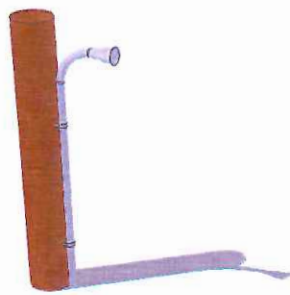

## MINIPŘELÍZKA 10

Věková skupina:  
3 - 12 let



Počet uživatelů



Rozměr konstrukce:  
d= 2,35 m  
š= 0,20 m  
h= 1,00 m



Výška pádu: 100 cm



ČSN EN 1176-1 : 2008



Tráva nebo udusaná  
hlína - 16m<sup>2</sup>



- materiál: dřevo akát / dub  
- spojovací materiál pozinkovaná ocel  
- síť z PP lán 16 mm s ocelovým jádrem

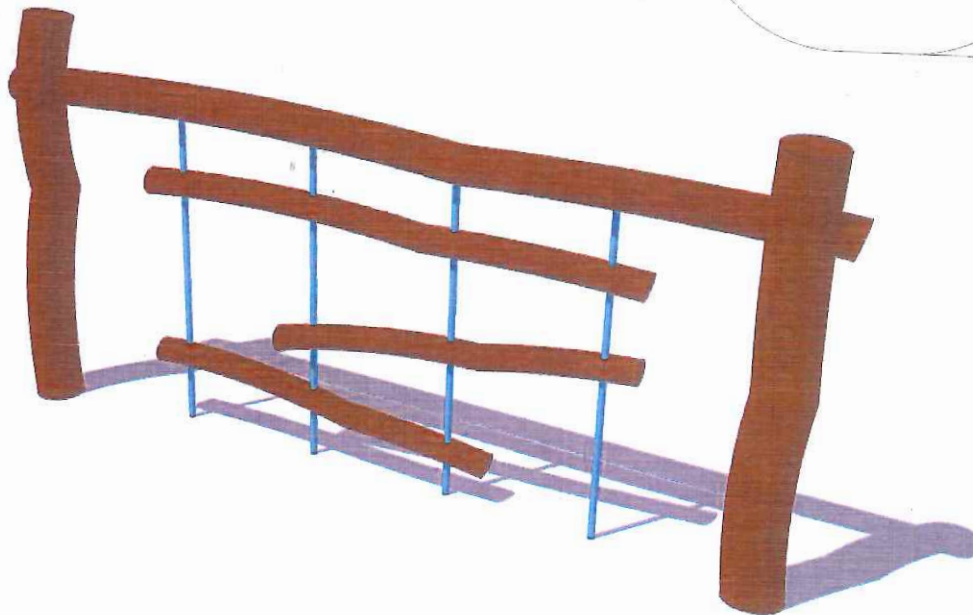

## HMYZI DOMEČEK

Věková skupina:  
bez omezení



Počet uživatelů



Rozměr konstrukce:  
d= 1,00 m  
š= 0,52 m  
h= 1,70 m



Výška pádu: 0 cm



ČSN EN 2008



Volný prostor bez  
tlumícího materiálu - 14m<sup>2</sup>

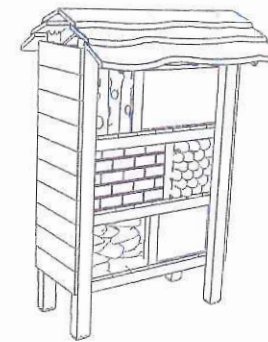

- materiál: dřevo akát / dub  
- spojovací materiál pozinkovaná ocel

